

ENVIRONMENTAL PROTECTION



Do not dispose of this product with the normal household waste at the end of its life cycle. Return it to a collection point for the recycling of electrical and electronic devices. This is indicated by the symbol on the product, user manual or packaging.

The materials are reusable according to their markings. By reusing, recycling or other forms of utilization of old devices you make an important contribution to the protection of our environment.

Please contact your local authorities for details about collection points.

| | | |
|--|--|--|
| | WARNING Risk of electric shock Do not open! | |
| Caution: To reduce the risk of electric shock, do not remove the cover (or back). There are no user serviceable parts inside. Refer servicing to qualified service personnel. | | |



This symbol indicates the presence of dangerous voltage inside the enclosure, sufficient enough to cause electric shock.



This symbol indicates the presence of important operating and maintenance instructions for the device.

Safety, Environmental and Setup Instructions

- Use the device in dry indoor environments only.
- Protect the device from humidity.
- Do not open the device. **RISK OF ELECTRIC SHOCK!** Refer opening and servicing to qualified personnel.
- Connect this device to a properly installed and earthed wall outlet only. Make sure the mains voltage corresponds with the specifications on the rating plate.
- Make sure the mains cable stays dry during operation. Do not pinch or damage the mains cable in any way.
- A damaged mains cable or plug must immediately be replaced by an authorized service center.
- In case of lightning, immediately disconnect the device from the mains supply.
- Children should be supervised by parents when using the device.
- Clean the device with a dry cloth only.
Do NOT use CLEANING AGENTS or ABRASIVE CLOTHS!
- Do not expose the device to direct sunlight or other heat sources.
- Install the device at a location with sufficient ventilation in order to prevent heat accumulation.
- Do not cover the ventilation openings!
- Install the device at a safe and vibration-free location.
- Install the device as far away as possible from computers and microwave units; otherwise radio reception may be disturbed.
- Do not open or repair the enclosure. It is not safe to do so and will void your warranty. Repairs only by authorized service/ customer center.
- Only use mercury and cadmium-free batteries.
- Used batteries are hazardous waste and NOT to be disposed of with the household waste!!!
Return the batteries to your dealer or to collection points in your community.
- Keep batteries away from children. Children might swallow batteries.
Contact a physician immediately if a battery was swallowed.
- Check your batteries regularly to avoid battery leakage.
- Batteries shall not be exposed to excessive heat such as sunshine, fire or the like.
- CAUTION: Danger of explosion if battery is incorrectly replaced
Replace only with the same or equivalent type



Used batteries are hazardous waste and NOT to be disposed of with the household waste! As a consumer you are legally obligated to return all batteries for environmentally responsible recycling - no matter whether or not the batteries contain harmful substances *).

Return batteries free of charge to public collection points in your community or to shops selling batteries of the respective kind.

Only return fully discharged batteries.

*) marked Cd = cadmium, Hg = mercury, Pb = lead

REMOTE CONTROL

Button description

| | |
|-------------------------|--|
| “Function” | Press to select the functions (Phono(AUX)/USB/DAB/FM) |
| “I/⏻ - On / Standby” | Press to power on / standby the system |
| “Skip ” ▶▶ / ◀◀ | In USB mode : to select next track / previous |
| “TUNE - / + “ | In DAB/FM mode : press to step up/down of frequency |
| “MEM / CLK-ADJ” | In USB mode : press to active USB program function In DAB/FM mode : press to active preset station mode In standby mode : press to adjust clock |
| “Play/pause ▶ / SCAN” | Press once to start USB playback. Press once again to pause the playback temporarily In FM/DAB mode, press to perform station Auto Scan function |
| “Stop ■ / ENTER” | In USB playback mode: press to terminate playback In USB stop mode: press to cancel programmed memory. In Tuner mode : select stereo/mono mode |
| “FOLDER/MEM.PRE ▲ / ▼” | In USB mode : press to skip up/down the Folder In Tuner mode : press to select preset memory up/down |
| “TS/ID3” | In encoding mode : press to active track separation function |
| “DELETE” | In MP3 playback mode : press to active ID3 function In USB mode : press to active file delete function In Phono / Aux-in mode : press to select the bit rate (128, 192 or 256 kbps) for USB encoding |
| “REC ●” | Press to active USB encoding function |
| “VOL -/+” | Press to adjust volume level down / up |
| “MUTE” | Press to mute the sound from speaker temporarily |
| “PRESET EQ” | Press to select difference EQ mode for enjoyment |
| “TIMER” | In standby mode : press to set the alarm on/off time and active/de-active alarm function |
| “SLEEP” | In Power on mode : press to active sleep function |
| “PLAY MODE / INFO” | In USB mode : press to active repeat / random playback mode In DAB/FM mode: press to display the broadcast information if available. |

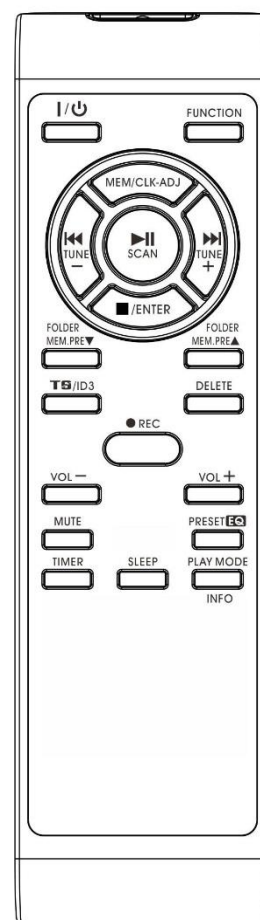

BATTERY INSTALLATION

- 1) The battery compartment is located on the back of the remote control.
- 2) Remove the battery compartment door by pressing in on the tab and lifting it off.
- 3) Insert two (2) AAA size batteries (not included) into the battery compartment following the polarity markings inside the battery compartment.
- 4) Replace the battery compartment door.

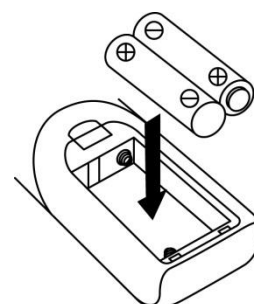

LOCATIONS OF CONTROLS

- 1) Skip / Tuning ►► / ◀◀ button
- 2) Stop ■ / ENTER button
- 3) MEM / CLK-ADJ button
- 4) Left speaker
- 5) FUNKTION knob
- 6) USB socket
- 7) 3.5 mm headphone jack
- 8) LCD display
- 9) Dust cover
- 10) Play/Pause ►|| / SCAN button
- 11) PLAY MODE / INFO button
- 12) Right speaker
- 13) "I/O - On / Standby / VOLUME" knob
- 14) Record ● button
- 15) 3.5mm AUX-IN jack
- 16) Remote sensor
- 17) Spindle adaptor
- 18) Turntable speed selector
- 19) Auto stop switch
- 20) Pick-up holder
- 21) Line out socket
- 22) DAB/FM antenna socket
- 23) AC line cord
- 24) Tone arm lift

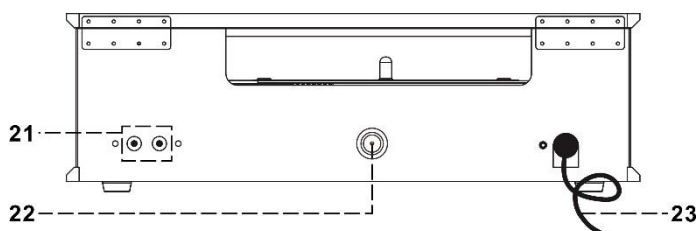
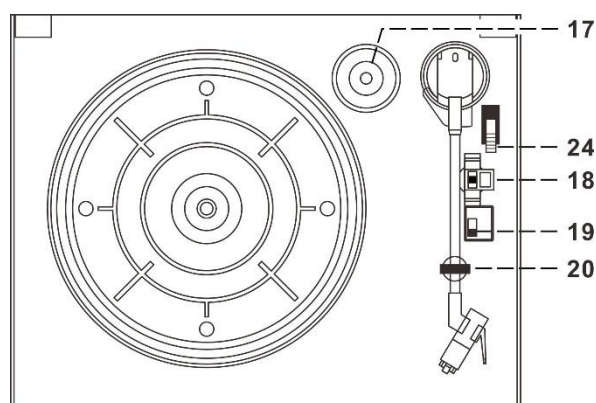
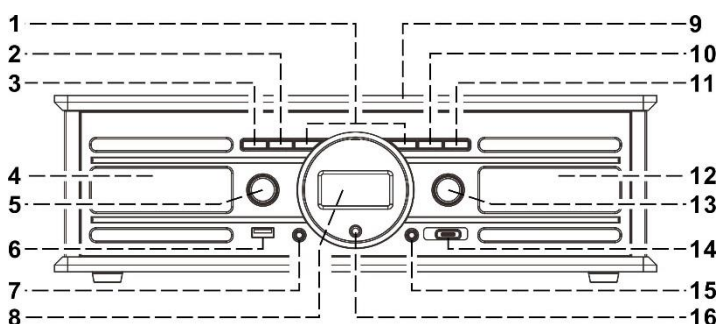

Caution:

Usage of controls or adjustments or performance of procedures other than those specified herein may result in hazardous radiation exposure.

This unit should not be adjusted or repaired by anyone except qualified service personnel.

CONNECT TO POWER

Precautions for use

- Unpack all parts and remove protective material.
- Do not connect the unit to the mains before checking the mains voltage and before all other connections have been made.
- Do not cover any vents and make sure that there is a space of several centimeters around the unit for ventilation.
- The unit is supplied with 4 screw covers. It is recommended to install the screw covers on both sides of the unit.

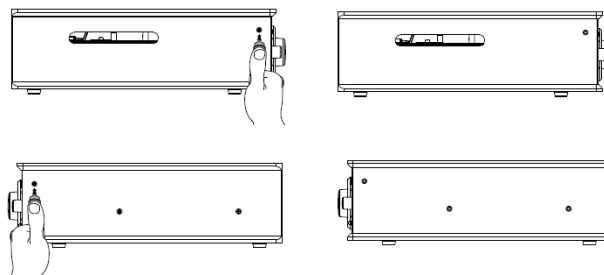

Setting up

1. Connect the power cord (23) to AC outlet
2. When you first plug the unit into the mains, the LCD display (8) will show " 0 : 00 ".
3. Turn on the unit by pressing ON/Standby/Volume knob (13), if the LCD display (8) is on with backlighting, it means the power supply is normal. Now your system is ready to play the music.

SETTING THE CLOCK

1. Set unit in standby mode.
 2. Press the "MEM / CLK-ADJ" button (3) once, the display will start flashing. Press Skip/Tuning ◀◀ or ▶▶ button (1) to select the appropriate area hour format(12hr/24hr)
 3. Press "MEM / CLK-ADJ" button (3) again, the first second digit of "00" is flashing. Press ◀◀ or ▶▶ button (1) to set the correct hour. Press "MEM / CLK-ADJ" button (3) to store the correct hour.
 4. The third fourth digit of "00" is flashing, press the ◀◀ or ▶▶ button (1) to set the correct minutes. Then press "MEM / CLK-ADJ" button (3) to store the correct minute.
- **The clock setting mode will automatically quit if no button is being pressed in a period of about 10 seconds after pressing the "MEM / CLK-ADJ" button.**
 - **The set time will be re-set completely if dis-connecting the main power supply. You are recommended to switch the system into standby mode for convenience usage.**

LISTENING TO RADIO – FM

Manual tuning

1. Plug in the provided DAB/FM tuner antenna to the antenna socket (22) then switch on the unit by "On/Standby" button (13), then turn the "FUNCTION" knob (5) to select "FM" mode.
2. Tune to the required station by ◀◀ or ▶▶ tuning button (1).
3. Turn the Volume knob (13) to the desired volume level.

1

Auto tuning

1. Set the unit to FM mode.
2. Press the "SCAN" button (10) once, unit will start to scan at tuning up direct until radio station received. Press and hold the "SCAN" button (10) for a second, the unit will scan to tuning down direction. If the radio data system (RDS) broadcasting signal received, the unit will set the actual time automatically.
3. Turn the Volume knob (13) to the desired volume level.

Radio data system (RDS)

This is the features to display the information which released from the radio broadcast and will showed on LCD display step by step as below by pressing the "Info" button (on the remote control) continuously.
 Radio text → program type → signal strength → date/time → frequency → mono/stereo.

LISTENING TO RADIO – DAB

Digital audio broadcasting (DAB) radio

1. Set the unit to "DAB" mode by Function Knob (5).
2. Press and hold the "SCAN" (10) button for about 2 seconds, unit will start to full scan for searching stations. Then press tuning ◀◀ or ▶▶ button (1) to select your desired DAB channel.
3. Press the "INFO" button continuously to check the below info released by DAB.
 Group name → frequency → transfer rate → signal strength → date/time → program type → scrolling text
4. Turn the Volume knob (13) to the desired volume level.

Manual Tuning

1. Set the unit to "DAB" mode by Function Knob (5).
2. Press and hold the "Stop ■ / ENTER" button" (2), the LCD display will show "Manual tune".
3. Press "Skip/Tuning ◀◀ or ▶▶ button" (1) to select the DAB district band (5A – 13F) for your area, and then press "Stop ■ / ENTER" button" (2) to confirm.
4. Press "Skip/Tuning ◀◀ or ▶▶ button" (1) to select the DAB radio station
5. To exit the manual tuning, press the "Stop ■ / ENTER" button" (2) once.

Preset stations

You can store up to total of 40 radio stations in the memory (20-FM/20-DAB).

1. Set to FM/DAB mode
2. Turn to the desired radio station by "manual" or "auto" tuning method.
3. Press and hold the "MEM/CLK-ADJ" button (3) around four second to enable memory state, the preset station will flash on LCD display.
4. Preset the Skip/ Pre up/down button (1) to select the desired station memory for storage.
5. Press "MEM/CLK-ADJ" button (3) to confirm the preset memory.
6. Repeat step 2 to 5 to store other stations.

Recall preset stations

1. Press the "MEM/CLK-ADJ" button (3) once to enable recall state
 2. Press "Skip/Tuning ◀◀ or ▶▶" button (1) to select the desired memory station.
 3. Press "MEM/CLK-ADJ" button (3) to confirm the recall memory station.
- It is also possible to press "MEM PRE ▲ / ▼" button on remote control, to select the desired memory station.
 - There are 3 seconds for program state, after 3 sec. This state would resume to normal tuner mode automatically.
 - You can overwrite a present station by storing another frequency in its place.

FM-Stereo reception

- Press the "ENTER" knob (2) repeatedly, the FM programs are receiving in mono and stereo mode repeatedly. In particular when stereo signals are weak, it is preferable to receive the program in Mono.

Hints for best reception:-

- FM/DAB : the receiver work with detachable DAB/FM wire antenna, made sure the antenna is plugged into the antenna socket (22), totally unraveled and proper for the best reception.

PHONO OPERATIONS

Please Note - Before Use

- Remove the stylus protector.
- Be sure that the tone arm is being detached from the tone arm rest before operating and re-secured again afterwards.

1. Turn the "FUNKTION" knob (5) to select "Phono/Aux" mode.
2. Set the speed selector (18) to the proper position depending on the record to be played.
3. Place the record on the platter (use the spindle adaptor (17) if required).
4. Lift the tone arm from the rest with the ton arm lift (24), slowly move it to the record side. The platter will start to rotate.
5. Place the tone arm by the ton arm lift (24) to the desired position of the record.
6. Adjust the volume Knob (13) to the desired level.
7. At the end of record, the platter will automatically stop rotating. Lift the tone arm from the record and return it to the rest.
8. To stop manually, lift the tone arm from the record and return it to the rest.

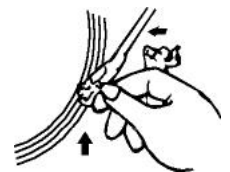
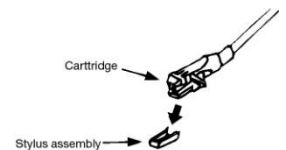

Remark : As some kind of record the auto-stop area was out of the unit setting, so it will stop before the last track finish. In this case, select the auto-stop switch (19) to "off" position, then it will run to the end of the record but will not stop automatically (turn off the unit by ON/Standby/volume knob (13) or switch back the auto-stop switch to "on" position to stop the platter rotate). Then put back the tone arm to the rest position.

AUX-IN CONNECTION

Connect the unit to any auxiliary device (i.e. MP3 player, or iPod® (not included) by connecting the aux in jack (15) with one end of 3.5mm stereo cable(not provided) and the other end connect to the auxiliary device to perform the music.

1. Turn the "FUNCTION" knob (5) to select "Phono/Aux" mode.
2. Plugged the Aux in jack. The channel with switch to Aux automatically.
3. Start to playback your device and adjust On-off/Volume knob (13) to the desire volume level. If the distortion was too high, reduce the volume level of your auxiliary device.

Remark : due to Aux and Phono were designed at the same position of this system. When Aux in jack (15) plugged by 3.5mm stereo plug. The channel will change to Aux-in function automatically and turntable will stop to rotate. Please ensure the Aux in jack (15) without plugged by anything before playing Phono.

PLAYBACK OF MP3 SONG VIA USB STORAGE MEDIA

Connecting

The system is able to decode and playback all MP3 file which stored in the memory media with USB connecting port.

Connecting the USB upside down or backwards could damage the audio system or the storage media. Check to be sure the direction is correct before connection.

1. Turn the "FUNCTION" knob (5) to select USB.
2. Plug-in the USB plug with the face up & make sure it going into completely.
3. The system will start reading the storage media after connecting, and LCD display (8) will show the total number of MP3 files and total number of folder being detected then will start playback automatically.

Remark: USB port does not support connection with USB extension cable and is not designed for communication with computer directly

● **Pause / Play mode**

To interrupt, press the "Play/Pause" button (10) once, the playing time will be freeze & flashing on the LCD display (8). Press again to resume normal playback.

● **STOP MODE ■**

If " Stop ■ " button (2) is pressed during play or pause mode, system will go to stop mode

● **Skip/search mode (skip/search up ►►/skip/search down ◀◀)**

1. During play or pause mode, if "Skip up ►►" button (1) is pressed. It will go to next track and display the track no. and then charge to play mode. Press "Skip down" ◀◀ (1) to repeat a track
2. Press within 2 seconds "skip down ◀◀" button (1) again, unit will go to the previous track and change to play mode.
3. If press and hold the " Skip up ►►/down ◀◀ button " (1) during MP3 playback, the playing track will go fast forward or backward until the button being released.

Folder up/down control (by remote handset)

1. Press " FOLDER ▼ / ▲ " button, to select the requested folder.
2. Press the " Play/Pause " button to start playback.

Remark:

- The system can detect and read the file under MP3 and format only though the USB port
- If connect the system to MP3 player via the USB socket, due to variances in MP3 encoding format, some MP3 player may not be able to play via the USB socket. This is not a malfunction of the system.

ID3 (track/album title) function (by remote handset)

1. Press the " ID3 " button during playback of MP3 file, the song title is being displayed. Press the " ID3 " button again to disable the function.

● **Play mode**

Press " PLAY MODE" button (11) before or during playback, a single track, single folder or all the tracks can be played in difference mode as follow:-



| Play mode | Indicator on LCD display |
|----------------------|--------------------------|
| Repeat single track | RPT-1 |
| Repeat all tracks | REP-ALL |
| Repeat single folder | REP-ALB |
| Random mode | RANDOM |
| Off mode | OFF |

- **Repeat play**

You can listen the desired tracks or all track or folder repeatedly by this function.

- **Random play**

You can listen all the tracks or folder in a random order by this function

Tracks programming

Up to 20 tracks can be programmed for MP3 file and play in any order. Before use, be sure the system is at stop mode before programming:-

1. Set in USB mode & set at stop mode.
2. Press the "MEM / CLK-ADJ" button (3), "MEMORY" will appear on LCD display (8). Moreover, it will indicate program no. and digits for track no. To be programmed.
3. Select a desired track by pressing "Skip up ►►" or down "◄◄" buttons (1).
4. Press the "MEM / CLK-ADJ" button(3) to store the trace into memory.
5. Repeat steps 3 and 4 to enter additional tracks into the memory if necessary.
6. When all the desired tracks have been programmed, press "Play/Pause" button (10) to play the disc in assigned order.
7. Press "Stop ■" button (2) to stop program playback
 - After program complete, press "Skip up ►►" or down "◄◄" button (1) to review the tracks being programmed.
 - Press "Stop ■" button (2) at stop mode to cancel all tracks being programmed.

ENCODING FROM PHOTO OR AUX-IN INTO MP3 FILE

The system is able to encode the Phono / Radio or Aux in to MP3 format and recording at memory media with USB connecting port.

A) Phono/Aux-in encoding

1. Turn "FUNCTION" knob (5) to select "Phono" mode (or Aux-in) and then press the "Record ●" button (14) directly.
2. The LCD display (8) will show the word "REC» USB" & flashing, now the system is starting the encoding mode.
3. Start playback at Phono (or Aux-in) for the track which you want to record.
4. To stop the recording, press and the "Record ●" button (14) until the LCD stop flashing and return to "Phono" mode.

B) DAB/FM encoding

1. Turn Function (5) to select "DAB/FM" mode and select the desire DAB/FM station.
2. Press the "Record ●" button (14) directly.
3. The LCD display (8) will show the word "REC» USB" & flashing, now the system is starting the encoding mode.
4. To Stop the recording, press the "Record ●" button (14) until the LCD (8) stop flashing.

Remark:-

- The recording speed is 1:1 and according to the actual playing time.
- The system will create a "audio" folder and then store the encoding track in it.
- The encoding format is preset at MP3, bit rate : 128 kbps, sampling rate : 44.1kHz.
- For Phono/Aux-in encoding, it's possible to change the recording bit rate:
 - Press "DELETE" button on the remote, the display will show e. g. "128 kbps"
 - Press "Skip up ►►" or down "◄◄" buttons to select the desired recording bit rate 192 or 256 kbps
 - Press "DELETE" button again to confirm.
- No song title will be recorded during encoding mode

C) Track separation (by remote handset)

- You can divide the recording music from phono, tuner or Aux-in to USB track by trace during encoding. Every time when press the "TS" (track separation) button once at remote handset during encoding from phono to USB, the system will generate a new track and continuous the recording. The current text at LCD display will show 'TS' one time, it mean the unit is creating a new track successfully but track separation feature was not available at Tuner mode.

FILE DELETE AT USB (BY REMOTE CONTROL)

The system is able to erase the file stored inside the USB pen drive by following:-

A) Single file delete

1. Playback the USB sound track which desired to delete, press and hold the “ DELETE “ button for 3 seconds and the LCD display (6) will show ‘DEL OK’ means the current track had delete successfully.

B) All files delete

1. Set USB on stop mode, press and hold the “ DELETE “ button for 3 seconds and the LCD display (6) will show “ FORMAT YES (NO) “
2. Press skip forward▶▶ or skip backward◀◀ button to select “ Yes “ or “ No “.
3. Press the “ DELETE “ button again to confirm the setting.

Remark : All the files inside the MP3 track USB storage media will be deleted completely after confirming to “ yes “ mode.

Removing of USB

To remove the USB, turn off the power or switch the function mode to either tuner or phono first. Then un-plug it by pulling out the USB socket directly.

MORE FEATURES

A. Sleep setting (by remote control)

1. Press “SLEEP” button and “ SLP 90 ” indicator shown on the LCD (8).
2. Keep pressing the “SLEEP” button to adjust the sleep timer in the order of 90 > 80 >70....10 minutes respectively and sleep icon “ Z ” will indicate & flashing on LCD.
3. System will stop and go to standby mode automatically after the selected timing.
4. To cancel the sleep mode, press “ SLEEP” button until “SLP-OFF” displayed and the “ Z “ indicator disappear on LCD display

Remark:-

If press the sleep button once and the Sleep indicator “ Z “ appear on the LCD (8), the system will go to standby mode automatically after selected minutes.

B. Alarm clock setting (by remote control)

This function allows the system to turn on automatically and wake you up by soft music or radio.

First, set the unit at standby mode then press and hold the “ Timer ” button to enter the timer program mode until the “ On time “ is flashing on LCD display, then you can start the alarm setting:-

- 1) On time setting : Press the “ TIMER “ button again(hour digit will flash) and “ Skip ◀◀ or ▶▶ ” button to set the hour. Then press again “TIMER ” to enter the hour, then press “TIMER” and “Skip ◀◀ or ▶▶ ” button to set the minute, press “TIMER” button enter the wake up setting mode
- 2) Wake up mode : Press “ FUNCTION ” button to set the wake up mode (USB / DAB / FM). Then press “ TIMER” button to enter the volume mode.
- 3) Volume level : Press “ Volume up/down ” button to set the volume level, then press “ TIMER ” button again to enter the off time mode setting.
- 4) Off time setting : Press the “ TIMER “ button and then press ““Skip ◀◀ or ▶▶” button to set the off time. Then press “TIMER“ button again to complete the setting.

Active/de-active timer function

To cancel alarm function by press again “TIMER” button until the timer indicator “⌚” disappear. Press again to active it and the time indicator “⌚” will show on LCD display.

Remark:-

- If there is no music source being detected (USB) when the preset time is reached, system will default to “FM” function for wake up mode automatically. The system will preset at the latest radio frequency being listened before switching off
- For FM/DAB wake up, the system will preset at the latest radio frequency being listened before switching off.
- To re-input the timer setting, repeat the alarm clock setting procedure.

C. Pre-set EQ function (by remote control)

This unit provides 4 differences sound mode to enhance your listening experience. You can select the desired effect by pressing the “PRESET EQ” button repeatedly at following sequence:-



D. Phones:

To listen to music privately, use headphones with a 3.5 stereo jack plug and connect it to the headphones socket. The speakers will then be muted.

Attention: To prevent possible hearing damage, do not listen at high volume levels for long periods.

E. Line Out Connection:

You can connect the system to your whole Hi-Fi system by connecting the Line out Socket (21) to the auxiliary input socket with a RCA cable (not included).

F. Factory reset

You can reset your radio and restore all of the original factory settings.

- Make sure you are under DAB Mode, press and hold the “Play Mode /Info button” (11) for at least 5 seconds. The display will show “System reset OK”.

Note: If you reset your radio all of your DAB station presets will be deleted.

TECHNICAL SPECIFICATIONS

| | |
|--------------------|--|
| Power Supply: | AC230V~50Hz |
| Power Consumption: | 20W |
| Output Power: | 2 x 2.5W RMS |
| Frequency Range: | FM: 87.5 – 108 MHz DAB+ Band III: 174 – 240 MHz |

Due to ErP stage two requirement and protect the environment, the unit will switch to standby mode automatically when no any music playing over 15 minutes.

IMPORTER

| | | |
|--------------------|--------|--|
| Wörlein GmbH | Tel.: | +49 9103 71 67 0 |
| Gewerbestr. 12 | Fax.: | +49 9103 71 67 12 |
| D 90556 Cadolzburg | Email: | service@woerlein.com |
| Germany | Web: | www.woerlein.com |

Technische Änderungen und Druckfehler vorbehalten
 Copyright by Woerlein GmbH, 90556 Cadolzburg, www.woerlein.com
 Vervielfältigung nur mit ausdrücklicher Genehmigung der Woerlein GmbH

