

ENVIRONMENTAL PROTECTION



Do not dispose of this product with the normal household waste at the end of its life cycle. Return it to a collection point for the recycling of electrical and electronic devices. This is indicated by the symbol on the product, user manual or packaging.

The materials are reusable according to their markings. By reusing, recycling or other forms of utilization of old devices you make an important contribution to the protection of our environment.

Please contact your local authorities for details about collection points.

CLASS 1 LASER PRODUCT
KLASSE 1 LASER PRODUKT
LUOKAN 1 LASER LAITE
KLASS 1 LASER APPARAT
PRODUCTO LASER CLASE 1

CAUTION - INVISIBLE LASER RADIATION WHEN OPENING THE COVER OR PRESSING THE SAFETY INTERLOCK. AVOID EXPOSURE TO THE LASER BEAM.

	WARNING Risk of electric shock Do not open!	
Caution: To reduce the risk of electric shock, do not remove the cover (or back). There are no user serviceable parts inside. Refer servicing to qualified service personnel.		



This symbol indicates the presence of dangerous voltage inside the enclosure, sufficient enough to cause electric shock.



This symbol indicates the presence of important operating and maintenance instructions for the device.

Safety, Environmental and Setup Instructions

- Use the device in dry indoor environments only.
- Protect the device from humidity.
- Do not open the device. **RISK OF ELECTRIC SHOCK!** Refer opening and servicing to qualified personnel.
- Connect this device to a properly installed and earthed wall outlet only. Make sure the mains voltage corresponds with the specifications on the rating plate.
- Make sure the mains cable stays dry during operation. Do not pinch or damage the mains cable in any way.
- A damaged mains cable or plug must immediately be replaced by an authorized service center.
- In case of lightning, immediately disconnect the device from the mains supply.
- Children should be supervised by parents when using the device.
- Clean the device with a dry cloth only.
Do NOT use CLEANING AGENTS or ABRASIVE CLOTHS!
- Do not expose the device to direct sunlight or other heat sources.
- Install the device at a location with sufficient ventilation in order to prevent heat accumulation.
- Do not cover the ventilation openings!
- Install the device at a safe and vibration-free location.
- Install the device as far away as possible from computers and microwave units; otherwise radio reception may be disturbed.
- Do not open or repair the enclosure. It is not safe to do so and will void your warranty. Repairs only by authorized service/ customer center.
- The device is equipped with a "Class 1 Laser". Avoid exposure to the laser beam as this could cause eye injuries.
- Only use mercury and cadmium-free batteries.
- Used batteries are hazardous waste and NOT to be disposed of with the household waste!!! Return the batteries to your dealer or to collection points in your community.
- Keep batteries away from children. Children might swallow batteries. Contact a physician immediately if a battery was swallowed.
- Check your batteries regularly to avoid battery leakage.



Used batteries are hazardous waste and NOT to be disposed of with the household waste! As a consumer you are **legally obligated** to return **all batteries** for environmentally responsible recycling – no matter whether or not the batteries contain harmful substances*).

Return batteries free of charge to public collection points in your community or to shops selling batteries of the respective kind.

Only return fully discharged batteries.

*) marked Cd = cadmium, Hg = mercury, Pb = lead

LOCATION OF CONTROLS

- 1) DUST COVER
- 2) LCD DISPLAY
- 3) CD TRAY OPEN/CLOSE BUTTON
- 4) CD TRAY
- 5) 3.5MM AUX IN JACK
- 6) 3.5MM HEADPHONE JACK
- 7) PANEL COVER
- 8) USB SOCKET
- 9) SD/MMC CARD SLOT
- 10) STANDBY LED INDICATOR
- 11) POWER ON/STANDBY BUTTON
- 12) FUNCTION BUTTON
- 13) MEMORY/CLOCK-ADJUST BUTTON
- 14) FOLDER/PRE-UP BUTTON
- 15) ● RECORD BUTTON
- 16) EJECT BUTTON
- 17) BAND / PLAY/PAUSE ►|| BUTTON
- 18) TUNING/SKIP UP►►/
- 19) STOP ■ BUTTON
- 20) TUNING/SKIP DOWN◄◄ BUTTON
- 21) ST/MONO-PLAY MODE BUTTON
- 22) PRESET EQ BUTTON
- 23) VOLUME UP/DOWN BUTTON
- 24) REMOTE SENSOR
- 25) SPINDLE ADAPTOR
- 26) STROBE ILLUMINATOR
- 27) ALIGNMENT SCREW WITH RUBBER COVER
- 28) COUNTER WEIGHT
- 29) ANTISKATING
- 30) CUEING LEVER
- 31) TONE-ARM LOCK
- 32) TURNTABLE SPEED SELECTOR
- 33) PITCH ADJUSTMENT
- 34) SPEAKER TERMINAL (L/R)
- 35) LINE OUT SOCKET (L/R)
- 36) 75 OHM FM SOCKET
- 37) AC CORD

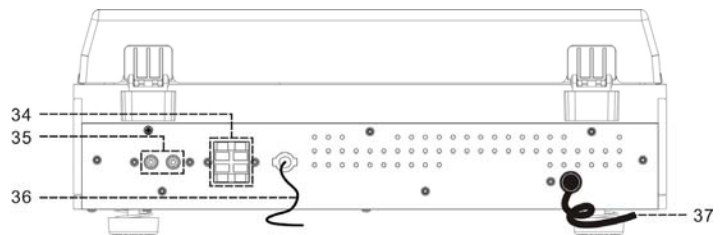
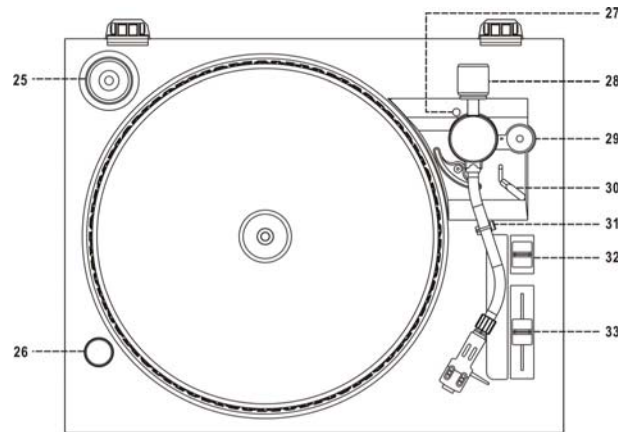
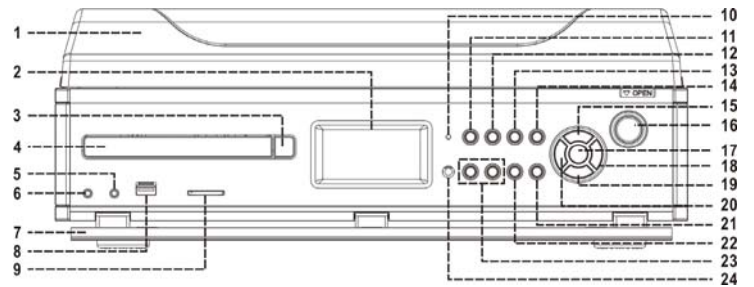

CAUTION:

USAGE OF CONTROLS OR ADJUSTMENTS OR PERFORMANCE OF PROCEDURES OTHER THAN THOSE SPECIFIED HEREIN MAY RESULT IN HAZARDOUS RADIATION EXPOSURE. THIS UNIT SHOULD NOT BE ADJUSTED OR REPAIRED BY ANYONE EXCEPT QUALIFIED SERVICE PERSONNEL.

PRECAUTIONS FOR USE

INSTALLATION

- UNPACK ALL PARTS AND REMOVE PROTECTIVE MATERIAL.
- DO NOT CONNECT THE UNIT TO THE MAINS BEFORE CHECKING THE MAINS VOLTAGE AND BEFORE ALL OTHER CONNECTIONS HAVE BEEN MADE.
- DO NOT COVER ANY VENTS AND MAKE SURE THAT THERE IS A SPACE OF SEVERAL CENTIMETERS AROUND THE UNIT FOR VENTILATION.

INSTALLATION OF COUNTER WEIGHT

1. SLIDE IN THE COUNTER WEIGHT COMPLETELY INTO THE REAR OF THE TONE ARM UNTIL IT REACH THE END, TURN IT CLOCKWISE UNTIL IT CLICK WITH PIT INSIDE.
2. TWIST THE COUNTER WEIGHT CLOCKWISE & BACKWARD UNTIL IT REACH THE WHITE LINE AS FIGURE 2
3. TWIST THE COUNTER MARKING UNTIL IT REACH " 1 " POSITION
4. TWIST THE COUNTER WEIGHT ANTI-CLOCKWISE & INWARD UNTIL IT REACH THE APPROPRIATE WORKING PRESSURE.

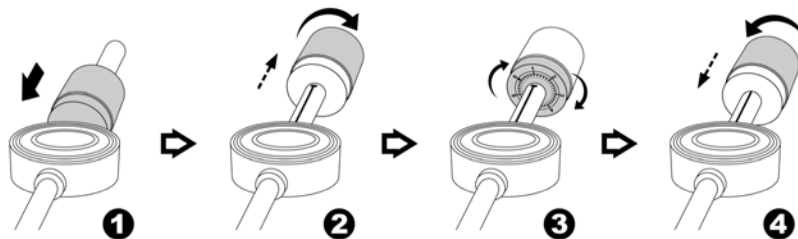

REMARK : THE WORKING PRESSURE OF THE PROVIDED STYLUS IS FROM THE RANGE **4 – 6 GRAMS** ACCORDING TO THE CARTRIDGE MANUFACTURER. ALL STYLUS HAS IT OWN WORKING PRESSUE AND PLEASE REFER TO THE SPECIFICATION RESPECTIVELY.

CONNECTION

1. CONNECT THE POWER CORD (37) TO AC OUTLET AND CONNECT THE SPEAKER WIRE TO THE SPEAKER TERMINAL (34) LOCATED ON THE REAR SIDE OF UNIT.
2. PRESS THE POWER BUTTON (11) AND IF STANDBY LED INDICATOR (10) LIGHT OFF, IT'S MEAN THE POWER SUPPLY IS NORMAL. NOW YOUR SYSTEM IS READY TO PLAY THE MUSIC.

SETTING THE CLOCK

1. SET UNIT IN STANDBY MODE.
 2. PRESS & HOLD THE "MEM/CLK-ADJ" BUTTON (13), THE LCD DISPLAY (2) WILL SHOW " SET CLOCK " AND THEN DISPLAY " 12HR OR 24 HR " PRESS SKIP◀◀ OR SKIP▶▶ BUTTON (18/20) TO SELECT THE APPROPRIATE AREA HOUR FORMAT(12HR/24HR). PRESS "MEM/CLK-ADJ" BUTTON (13) AGAIN TO CONFIRM.
 3. THE LCD (2) WILL DISPLAY THE FIRST & SECOND DIGIT OF "00" IS FLASHING. PRESS SKIP◀◀ OR SKIP▶▶ BUTTON (18/20) TO SET THE CORRECT HOUR. PRESS "MEM/CLK-ADJ" BUTTON (13) TO STORE THE CORRECT HOUR.
 4. THE THIRD & FOURTH DIGIT OF "00" IS FLASHING, PRESS THE SKIP◀◀ OR SKIP▶▶ BUTTON (18/20) TO SET THE CORRECT MINUTES. THEN PRESS "MEM/CLK-ADJ" (13) TO STORE THE CORRECT MINUTE.
- **THE PRE-SET TIME WILL BE RE-SET COMPLETELY IF DIS-CONNECTING THE MAIN POWER SUPPLY. YOU ARE RECOMMENDED TO SWITCH THE SYSTEM INTO STANDBY MODE FOR CONVENIENCE USAGE.**

LISTENING TO RADIO

MANUAL TUNING

1. PRESS FUNCTION BUTTON (12) TO SELECT " TUNER " MODE.
2. PRESS "BAND / ▶||" BUTTON (17) TO SELECT DESIRED BAND (MW OR FM).
3. TUNE TO THE REQUIRED STATION BY PRESSING THE " TUNING / SKIP UP ▶▶ OR DOWN ◀◀ (18/20) BUTTON.
4. ADJUST VOLUME CONTROL (23) TO THE DESIRED VOLUME LEVEL.

AUTO TUNING

1. PRESS FUNCTION BUTTON (12) TO SELECT " TUNER " MODE
2. PRESS " BAND / ▶|| " BUTTON (17) AND SELECT THE DESIRED BAND (MW (AM) OR FM).
3. PRESS AND HOLD THE " SKIP / TUNING UP ▶▶ OR DOWN ◀◀ (18/20) BUTTON FOR 1-2 SECONDS AND THEN RELEASE
4. THE UNIT WILL START SEEKING AUTOMATICALLY AND STOP UNTIL A RADIO STATION IS REACHED.
5. REPEAT STEP 3 & 4 UNTIL THE DESIRED RADIO STATION IS BEING REACHED.
6. ADJUST VOLUME UP/DOWN CONTROLS (23) TO THE DESIRED VOLUME LEVEL.

PRESET STATIONS

YOU CAN STORE UP TO TOTAL OF 40 RADIO STATIONS (30 FM,10 AM) IN THE MEMORY.

1. SET TO " TUNER " MODE
2. TURN TO THE DESIRED RADIO STATION BY " MANUAL " OR " AUTO " TUNING METHOD.
3. PRESS " MEM / CLK-ADJ " BUTTON (13) TO ENABLE PROGRAM STATE.
4. PRESS " FOLDER / PRE-UP (14) OR FOLDER / PRE-DOWN ▼ BUTTON (AT REMOTE HANDSET) TO SELECT THE DESIRED STATION MEMORY POSITION FOR STORAGE.
5. PRESS "MEM / CLK-ADJ" BUTTON (13) AGAIN TO CONFIRM THE SETTING.
6. REPEAT STEP 2 TO 5 TO STORE OTHER STATIONS.
7. PRESS " FOLDER / PRE-UP ▲ OR DOWN ▼ " BUTTON AT REMOTE HANDSET TO SELECT THE PRESET STATIONS IN ORDER.
8. TO RETURN NORMAL TUNER MODE, LEAVE KEYS FREE.

- **THE PRE-SET MEMORIES WILL BE CANCELLED COMPLETELY IF SWITCHING OFF THE MAIN POWER BUTTON ON SYSTEM. YOU ARE RECOMMENDED TO SWITCH THE SYSTEM INTO STANDBY MODE FOR CONVENIENCE USAGE.**
- YOU CAN OVERWRITE A PRESET STATION BY STORING ANOTHER FREQUENCY IN ITS PLACE.

FM & FM-STEREO RECEPTION

- PRESS THE “FM-ST/MONO” BUTTON (21) REPEATEDLY, THE FM PROGRAMS ARE RECEIVING IN MONO AND STEREO MODE REPEATEDLY. IN PARTICULAR WHEN STEREO SIGNALS ARE WEAK. IT IS PREFERABLE TO RECEIVE THE PROGRAM IN MONO.
- IF STEREO SIGNAL IS BEING RECEIVED, THE “ST” INDICATOR “**(ST)**” WILL APPEAR ON LCD DISPLAY (2) TO SHOW FM STEREO PROGRAM IS NOW RECEIVING.

HINTS FOR BEST RECEPTION:-

- AM : THE RECEIVER HAS A BUILD-IN AM BAR ANTENNA. IF AM RECEPTION IS WEAK, SLIGHT ROTATE OR RE-POSITIONING OF THE UNIT WILL USUALLY IMPROVE THE AM RECEPTION.
- FM : THE RECEIVER HAS A BUILD-IN FM WIRE ANTENNA (36) HANGING AT THE REAR CABINET. THIS WIRE SHOULD BE TOTALLY UNRAVELED AND EXTENDED FOR THE BEST RECEPTION.

PLAYING COMPACT DISC

● **GETTING START**

1. PRESS FUNCTION BUTTON (12) TO SELECT “CD” MODE.
2. PRESS “CD TRAY OPEN/CLOSE” BUTTON (3) TO OPEN THE CD TRAY (4).
3. PLACE A CD WITH THE PRINTED SIDE FACING UP INSIDE THE TRAY & THEN CLOSE IT BY CD TRAY OPEN/CLOSE BUTTON(3).
4. FOCUS SEARCH IS PERFORMING, THE LCD DISPLAY (2) WILL SHOW THE TOTAL NUMBER OF TRACKS & TOTAL PLAYING TIME.

● **PLAY / PAUSE MODE ►||**

1. PRESS THE “BAND/►||” BUTTON (17) TO START PLAYBACK, THE FIRST TRACK WILL START PLAYBACK.
2. TO INTERRUPT, PRESS THE “BAND/►||” BUTTON (17) ONCE, AND THE PLAYING TIME WILL BE FREEZE & FLASING ON THE LCD DISPLAY (2). PRESS AGAIN TO RESUME NORMAL PLAYBACK.

● **STOP MODE ■**

1. IF “STOP ■” BUTTON (19) IS PRESSED DURING PLAY OR PAUSE MODE, SYSTEM WILL GO TO STOP MODE.

● **SKIP MODE (SKIP UP ►► / SKIP DOWN ◄◄)**

1. DURING PLAY OR PAUSE MODE, IF “SKIP UP ►►” BUTTON (18) IS PRESSED. IT WILL GO TO NEXT TRACK AND DISPLAY THE TRACK NO. AND THEN REMAIN THE PLAY OR PAUSE MODE.
2. DURING PLAY OR PAUSE MODE, IF “SKIP DOWN ◄◄” BUTTON (20) IS PRESSED. IT WILL GO BACK TO THE BEGINNING OF THE TRACK, ORIGINAL TRACK NO. IS DISPLAY AND REMAIN THE PLAY OR PAUSE MODE.
3. AFTER STEP 2, PRESS “SKIP DOWN ◄◄” BUTTON (20) AGAIN WILL GO TO THE PREVIOUS TRACK AND REMAIN THE PLAY OR PAUSE MODE.

● **FOR MP3 DISC**

1. AFTER FOCUS SEARCH IS PERFORMING, THE TOTAL NUMBER OF TRACK AND ABLUM WILL BE SHOWN ON THE LCD DISPLAY (2).
2. PRESS “FOLDER/ PRE-UP “ (14) TO SELECT THE ALBUM NUMBER.
3. PRESS “SKIP UP ►►” “OR “SKIP DOWN ◄◄” “ BUTTON (18/20) TO SELECT THE TRACK NUMBER.
4. WHEN THE DESIRED TRACK AND ALBUM IS BEING SELECTED, PRESS THE “BAND/►||” BUTTON (17) TO START PLAYBACK.

ID3 (TRACK/ALBUM TITLE) FUNCTION (BY REMOTE HANDSET)

PRESS THE “INFO” BUTTON UNTIL THE LCD DISPLAY (2) SHOW “FILE - ...” DURING PLAYBACK OF MP3/WMA FILE, THE SONG TITLE / ARTIST NAME / ALBUM NAME IS BEING DISPLAYED IN SEQUENCE . PRESS THE “INFO” BUTTON AGAIN TO DISABLE THE FUNCTION.

REMARK:-

- IN THAT CASE OF NO NAME HAD BEEN ASSIGNED FOR THE TRACK, “NO TITLE “ OR “NO ARTIST “ IS BEING DISPLAYED” ON LCD DISPLAY (2).
- NO TITLE/ALBUM NAME CAN BE RECOGNIZED IF THE INPUT FORMAT ON THE DISC/MASS MEDIA IS NOT SUPPORTING BY THE SYSTEM.
- THE SYSTEM SUPPORT ONLY ENGLISH AND NUMERAL FOR ID3 FUNCTION

SONG TITLE/FOLDER NAME SEARCH FUNCTION (BY REMOTE HANDSET)

YOU CAN SEARCH THE TRACK BY THE TITLE/FOLDER NAME IN DISC DURING STOP OR PLAYBACK MODE:-

1. PRESS THE “ FIND “ BUTTON ONCE, THEN PRESS THE “SKIP UP▶▶▶” OR SKIP DOWN◀◀◀ BUTTON (18/20), YOU CAN SEARCH THE TITLE OF EACH SONG ONE BY ONE UNDER ALPHABET ORDER & THE NUMBER (A TO Z & THEN 0 TO 9) ORDER ON LCD DISPLAY (2), THEN PRESS THE “ BAND/▶▶▶ ” BUTTON (17) TO START THE PLAYBACK OF THE SELECTED TRACK.
2. PRESS AGAIN “ FIND ” BUTTON, THE FOLDER NAME IS BEING DISPLAYED. THEN PRESS THE “SKIP UP▶▶▶” OR SKIP DOWN◀◀◀ BUTTON (18/20), TO SELECT THE DESIRED FOLDER, AND PRESS THE “ BAND/▶▶▶ ” BUTTON (15) TO START THE PLAYBACK OF ALL TRACKS INSIDE THAT SELECTED FOLDER.

REMARK:-

MP3/WMA TRACK FORMAT REQUIREMENT:-

- MP3 BIT RATE : 32 KBPS~256 KBPS AND WMA BIT RATE : 32 KBPS ~ 320 KBPS
- THE PERFORMANCE OF PLAYING MP3 DISC IS VARIOUS FROM THE QUALITY OF RECORDING DISC AND THE METHOD OF RECORDING. FURTHERMORE, THE SEARCHING LEAD-TIME FOR MP3-CD IS LONGER THAN NORMAL CD DUE TO DIFFERENCE FORMAT.

● **PLAY MODE**

PRESS THE PLAY MODE BUTTON (21) DURING PLAYBACK TO SELECT REPEAT AND RANDOM FUNCTION, A SINGLE TRACK, SINGLE FOLDER (MP3 ONLY) OR ALL THE TRACKS CAN BE PLAYED IN DIFFERENCE MODE AS FOLLOW:-

FOR CD

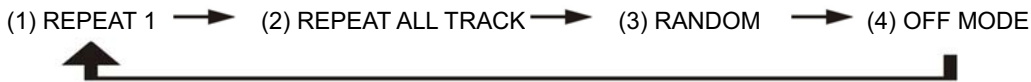

PLAY MODE	INDICATOR ON LCD DISPLAY
REPEAT TRACK	
REPEAT ALL	ALL
RANDOM	RAN
OFF MODE	-----

FOR MP3/WMA DISC/FILE



PLAY MODE	INDICATOR ON LCD DISPLAY
REPEAT SINGLE TRACK	
REPEAT SINGLE FOLDER	FOLDER
REPEAT ALL TRACKS	ALL
RANDOM MODE	RAN
OFF MODE	-----

● **REPEAT PLAY**

YOU CAN LISTEN THE DESIRED TRACKS OR FOLDER REPEATEDLY BY THIS FUNCTION.

● **RANDOM PLAY**

YOU CAN LISTEN ALL THE TRACKS IN A RANDOM ORDER BY THIS FUNCTION

CD / MP3 DISC PROGRAMMING

UP TO 40 TACKS CAN BE PROGRAMMED FOR DISC PLAY IN ANY ORDER. BEFORE USE, BE SURE TO PRESS THE “ STOP ■ “ BUTTON (19)



1. SET IN CD MODE & STOP THE PLAYBACK.
2. PRESS THE “MEM/CLK-ADJ” BUTTON (13) , “ MEM “ WILL APPEAR ON LCD DISPLAY (2). MOREOVER, IT WILL INDICATE PROGRAM NO. AND DIGITS FOR TRACK NO. TO BE PROGRAMMED – “ 01 PR 01 “.

3. SELECT A DESIRED TRACK BY PRESSING SKIP UP▶▶▶ OR DOWN ◀◀◀ BUTTONS (18/20).
 4. PRESS THE“ MEM/CLK-ADJ ” BUTTON (13) TO STORE THE TRACK INTO MEMORY.
 5. REPEAT STEPS 3 AND 4 TO ENTER ADDITIONAL TRACKS INTO THE MEMORY IF NECESSARY.
 6. WHEN ALL THE DESIRED TRACKS HAVE BEEN PROGRAMMED, PRESS “ BAND/▶▶ ” BUTTON (17) TO PLAY THE DISC IN ASSIGNED ORDER.
 7. PRESS “ STOP ■ ” BUTTON (19) TO TERMINATE PROGRAM PLAY.
- AFTER PROGRAM COMPLETE, PRESS “MEM/CLK-ADJ” BUTTON (13) REPEARTLY TO REVIEW THE TRACKS BEING PROGRAMMED.
 - PRESS “ STOP ■ “ BUTTON (19) AT CD STOP MODE TO CANCEL ALL PROGRAMMED MEMORY.
 - FOR MP3 DISC / FILE, PRESS THE “ FOLDER / PRE-UP “ BUTTON (14) TO SELECT THE 1ST TRACK OF NEXT FOLDER DIRECTLY AND HENCE TO SPEED UP THE SONG SELECTION.
 - THE PROGRAMMING MODEL WILL AUTOMATICALLY STOP IF NO BUTTON IS BEING PRESSED IN A PERIOD OF ABOUT 10 SECONDS AFTER PRESSING THE “ MEM/CLK-ADJ “ BUTTON (13).

PLAYBACK OF MP3/WMA SONG VIA USB STORAGE MEDIA OR MEMORY CARD

CONNECTING

THE SYSTEM IS ABLE TO DECODE AND PLAYBACK ALL MP3 /WMA FILE WHICH STORED IN THE MEMORY MEDIA WITH USB CONNECTING PORT OR SD/MMC MEMORY CARD.

1. SET THE SYSTEM AT STANDBY MODE FIRST OR OTHER FUNCTION EXCEPT SD OR USB MODE.
2. PLUG-IN THE USB PEN-DRIVE WITH THE FACE UP & MAKE SURE IT GOING INTO COMPLETELY OR INSERT THE MEMORY CARD IN THE DIRECTION OF THE ARROW AS SHOWN IN THE LABEL ON THE UNDERSIDE OF THE MEMORY CARD SLOT COVER. INSERT STRAIGHT WITHOUT BENDING.
- **CONNECTING THE USB UPSIDE DOWN OR BACKWARDS COULD DAMAGE THE AUDIO SYSTEM OR THE STORAGE MEDIA (USB THUMB DRIVE / SD/MMC CARD). CHECK TO BE SURE THE DIRECTION IS CORRECT BEFORE CONNECTION.**
3. PRESS FUNCTIONS BUTTON (12) TO SELECT “  “ SD CARD MODE OR “  “ USB MODE.
4. THE SYSTEM WILL START READING THE STORAGE MEDIA AUTOMATICALLY AFTER CONNECTING, AND LCD DISPLAY (2) WILL SHOW THE TOTAL NUMBER OF MP3/WMA FILES BEING DETECTED.
5. REPEAT THE SAME PLAYBACK PROCEDURE AS PLAYING CD/MP3 DISC AS ABOVE.

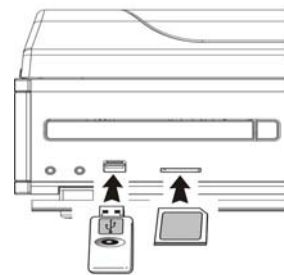

REMARK



- THE SYSTEM CAN DETECT AND READ THE FILE UNDER MP3 AND WMA FORMAT ONLY THOUGH THE USB PORT.
- **IF CONNECT THE SYSTEM TO MP3 PLAYER VIA THE USB SOCKET, DUE TO VARIANCES IN MP3 ENCODING FORMAT, SOME MP3 PLAYER MAY NOT BE ABLE TO PLAY VIA THE USB SOCKET. THIS IS NOT A MAUFUNCTION OF THE SYSTEM.**
- **USB PORT DOES NOT SUPPORT CONNECTION WITH USB EXTENSION CABLE AND IS NOT DESIGNED FOR COMMUNICATION WITH COMPUTER DIRECTLY**

ENCODING OF CD/PHONO INTO MP3 FILE TO USB MEMORY

THE SYSTEM IS ABLE TO ENCODE NORMAL CD OR TURNTABLE TO MP3 FORMAT AND RECORDING AT MEMORY MEDIA WITH USB CONNECTING PORT (OR SM/MMC CARD SLOT). BEFORE STARTING THE ENCODING, PLEASE INSERT THE MEMORY MEDIA (USB PEN DRIVE OR SD/MMC CARD) TO THE SYSTEM & MAKE SURE IT HAD ADEQUATE FREE MEMORY SIZE FOR RECRODING:-

A) CD ENCODING

I) ECNODING 1 TRACK / 1 DISC

1. PERFORM NORMAL PLAYBACK OF THE CD TRACK YOU WANT TO ENCODE & RECORD,
2. PRESS “ ● REC “ BUTTON (15) DURING THE PLAYBACK OF THE DESIRE TRACK AND THE SYSTEM WILL START ENCODING.
3. THE SYSTEM WILL SHOW “  ” & “  “ AND FLASHING. ENCODING IS PERFORMING NOW.
4. PRESS THE “ ● REC “ BUTTON (15) REPEARTLY AGAIN TO SELECT RECORD 1 TRACK “ REC_ONE “ OR RECORD ONE ENTIRE DISC “ REC_ALL “.
5. AFTER COMPLETING OF RECRODING, UNIT WILL STOP PLAYBACK AUTOMATICALLY.

II) ENCODING BY PROGRAM

1. PLACE A CD WITH THE PRINTED SIDE FACING UP INSIDE THE TRAY & THEN CLOSE THE CO TRAY.
2. SELECT THE DESIRE TRACKS BY FOLLOWING “ **CD DISC PROGRAMMING** “ PROCEDURES. THEN PRESS “ CD PLAY/PAUSE “ BUTTON (17) TO START PLAYBACK.

3. PRESS THE " ● REC " BUTTON (15) AND THE UNIT WILL DISPLAY " ↔ " & " REC " AND FLASHING. ENCODING IS NOW PERFORMING.
4. PRESS THE " ● REC " BUTTON (15) REPEATLY AGAIN TO SELECT " REC_ALL ".
5. AFTER COMPLETED OF ENCODING ACCORDING TO THE PRESET PROGRAM, UNIT WILL STOP PLAYBACK AUTOMATICALLY.

REMARK:-

- SAME OPERATION PROCEDURE FOR ENCODING TO SD/MMC CARD.
- IF BOTH RECRODING SOURCE (USB PEN DRIVE AND SD/MMC CARD) BEING DETECTED BY THE SYSTEM DURING ENCODING, PLEASE PRESS "SKIP UP▶▶" OR DOWN "◀◀" BUTTON (18/20) TO SELECT THE DESIRE SOURCE. THEN PRESS " ● REC " BUTTON (15) AGAIN TO CONTINUOUS THE PROCESS.
- THE RECORDING SPEED IS 1:1 AND ACCORDING TO THE ACTUAL PLYING TIME OF THE CD TRACK
- THE SYSTEM WILL CREAT A " AUDIO " FOLDER AND THEN STORE THE ENCODING TRACK IN IT.
- THE RECORDING FORMAT IS PRESET AT – MP3 BIT RATE : 128 KBPS, SAMPLING RATE : 44.1KHZ
- NO SONG TITLE WILL BE RECORDED DURING ENCODING MODE
- TO INTERRUPT THE RECRODING, PRESS THE" STOP ■ " BUTTON (19) DURING RECORDING MODE.
- **RECORDING WILL BE COMPLETED ONLY ENTIRE SONG BEING ENCODED, IF TERMINATE THE ENCODING PROCESS INTERMEDIATELY, THERE IS NO TRACK BEING RECORDED NOR STORED TO THE USB OR SD/MMC CARD**

III) COPYING OF MP3/WMA FILE

IF PUTTING A MP3/WMA DISC INSTEAD OF A CD-DISC, THE SYSTEM WILL COPY THE FILES TO THE USB OR SD/MMC CARD IF PRESS THE " ●REC " BUTTON (15). THE OPERATION PROCEDURES IS SAME AS CD ENCODING AS STIPULATE ON ABOVE, AND THE SYSTEM WILL SWITCH TO COPYING MODE ONLY IF MP3/WMA FILE BEING READ.

REMARK:

- THE SYSTEM WILL STORE THE FILE TO USB SOURCE FIRST IF BOTH USB AND SD SLOT ARE BEING OCCUPIED BY STORAGE MEDIA.
- THE SYSTEM WILL CREAT A " FCOPY " FOLDER AND THEN STORE ALL COPY FILE IN IT.
- IF PRESS THE" ● REC " BUTTON (15) DURING PLAYBACK OF USB OR SD SOURCE, THE FILE WILL COPY FROM USB TO SD OR SD TO USB.

B) PHONO ENCODING

- 1) SELECT " PHON/AUX " MODE AND THEN PRESS THE " ●REC " BUTTON (15) DIRECTLY.
- 2) THE LCD DISPLAY (2) WITH SHOW " ↔ " & " REC " AND FLASHING AFTER FEW SECONDS. NOW THE SYSTEM IS STARTING THE ENCODING MODE.
- 3) START PLAYBACK AT PHONO FOR THE TRACK WHICH YOU WANT TO RECORD TO USB POSITION.
- 4) AFTER FINISH OF RECODING, PRESS THE " STOP ■ " BUTTON (19) UNTIL THE TEXT ON LCD DISPLAY (2) STOP FLASHING AND RETURN TO " PHON/AUX " MODE.

C) RADIO ENCODING

- 1) SELECT " TUNER " MODE AND THEN SELECT THE DESIRE RADIO STATION
- 2) PRESS THE" ●REC " BUTTON (15) TO START THE ENCODING.
- 3) THE LCD DISPLAY (2) WITH SHOW " ↔ " & " REC " AND FLASHING AFTER FEW SECONDS. NOW THE SYSTEM IS STARTING THE RECORDING.
- 4) AFTER FINISH OF RECODING, PRESS THE " STOP ■ " BUTTON (19) UNTIL THE TEXT ON LCD DISPLAY (2) STOP FLASHING AND RETURN TO " TUNER " MODE.

REMARK:-

- IF THE RADIO RECEPTION SIGNAL IS NOT STRONG ENOUGH, THE SYSTEM CANNOT START THE ENCODING PROCESS AND THE TEXT " NO GOOD " WILL SHOW ON THE LCD DISPLAY (2).
- THE RECRODING QUALITY AND PERFORMANCE FOR RADIO ENCODING IS NOT STABLE DUE TO INTERFERENCE OF RADIO RECEPTION. THIS IS NOT A MAUFUNCTION OF THE SYSTEM.

D) AUX-IN ENCODING

CONNECT ANOTHER AUDIO DEVICE, E.G. (PORTABLE) CD PLAYER, MP3 PLAYER, (PORTABLE) CASSETTE PLAYER, IPOD, ETC. TO THIS SYSTEM VIA A CORD WITH 3.5MM DIA JACK PLUGS (NOT SUPPLIED).

CONNECT ONE END OF THIS CORD TO THE 3.5MM DIA. HEADPHONE JACK ON THE EXTERNAL DEVICE AND THE OTHER END TO THE 3.5MM AUX-IN JACK (5) ON THE SIDE OF THE UNIT.

WHEN CONNECTED IN THIS WAY IT IS POSSIBLE TO:

SELECT "PHONO/AUX" MODE. ONCE 3.5MM PLUG PLUGGED T THE AUX IN JACK. CHANNEL WILL CHANGE TO AUX IN AUTOMATICALLY.

- PLAY BACK THE MUSIC ALREADY ON THE CONNECTED DEVICE.

- ENCODE AND CONVERT THE MUSIC FILES FROM THE CONNECTED DEVICE TO USB/SD INTO MP3 FORMAT. FOLLOW THE SAME PROCEDURE AS DESCRIBED IN THIS MANUAL.

TRACK SEPARATION (BY REMOTE HANDSET)

YOU CAN DIVIDE THE RECORDING MUSIC FROM PHONO, OR RADIO TO USB/SD TRACK BY TRACK DURING ENCODING. EVERY TIME WHEN PRESS THE “ **TS** ” (TRACK SEPARATION) BUTTON ONCE AT REMOTE HANDSET DURING ENCODING FROM PHONO, TAPE OR RADIO TO USB/SD, THE SYSTEM WILL GENERATE A NEW TRACK AND CONTINUOUS THE RECORDING. THE TEXT “ PHONO ”, OR “ TUNER ” AT LCD DISPLAY (2) WILL FLASHING ONE TIME, IT MEAN THE UNIT IS CREATING A NEW TRACK SUCCESSFULLY.

ENCODING BITRATE (BY REMOTE HANDSET)

YOU CAN SELECT THE DESIRED BITRATE DURING ENCODING FROM CD/TAPE/PHONO/RADIO AND AUX-1 IN TO USB OR SD, THE SELECTABLE RANGE FROM 64 / 128 / 192 Kbps.

1. SET IN “ PHON/AUX ” FUNCTION (12) & REMAIN STOP MODE.
2. PRESS THE “ INFO ” FUNCTION AND THE LCD DISPLAY WILL SHOW THE DEFAULT BITRATE (128 Kbps)
3. PRESS SKIP **▶▶** OR **◀◀** BUTTONS (18/20) TO SELECT THE DESIRED BITRATE FOR ENCODING.
4. PRESS AGAIN THE “ INFO ” BUTTON TO CONFIRM THE SETTING AND THE LCD DISPLAY (21) RESUME TO “ PHON/AUX ” MODE

FILE DELETE AT USB / SD CARD (BY REMOTE CONTROL)

THE SYSTEM IS ABLE TO ERASE THE FILE STORED INSIDE THE USB PEN DRIVE OR SD CARD BY FOLLOWING:-

A) SINGLE FILE DELETE (BY REMOTE HANDSET)

1. PRESET AT “ USB ” OR “ SD ” MODE.
2. PRESS THE “ DELETE ” BUTTON AND THE LCD DISPLAY (2) WILL SHOW (DEL ---001)
3. PRESS SKIP FORWARD **▶▶** OR SKIP BACKWARD **◀◀** BUTTON TO SELECT THE FILE GOING TO DELETE.
4. PRESS THE “ DELETE ” BUTTON TO ENTER “ YES / NO ” MODE AND THEN PRESS SKIP FORWARD **▶▶** OR SKIP BACKWARD **◀◀** TO SELECT “ YES ” OR “ NO ”.
5. PRESS THE “ DELETE ” BUTTON AGAIN TO CONFIRM THE SETTING.

REMARK :

- PRESS “ STOP ” BUTTON ONCE AT REMOTE HANDSET TO QUIT DELETE MODE

REMOVING OF USB / MEMORY CARD

TO REMOVE THE USB / MEMORY CARD, TURN OFF THE POWER OR SWITCH THE FUNCTION MODE TO EITHER CD, PHONO OR TUNER FIRST. FOR USB PORT – UN-PLUG IT BY PULLING OUT THE USB SOCKET DIRECTLY, FOR MEMORY CARD – PULLING OUT THE SD CARD SMOOTHLY.

PHONO

OPERATION

- REMOVE THE STYLUS PROTECTOR.
- BE SURE THAT THE TONE ARM IS BEING DETACHED FROM THE TONE ARM REST BEFORE OPERATING AND RE-SECURED AGAIN AFTERWARDS.

1. PRESS FUNCTION BUTTON (12) TO SELECT “ PHONO/AUX ” MODE. THE LCD DISPLAY (2) WILL SHOW “ PHONO/AUX ”.
2. SET THE SPEED SELECTOR (32) TO THE PROPER POSITION DEPENDING ON THE RECORD TO BE PLAYED.
3. PLACE THE RECORD ON THE PLATTER (USE THE SPINDLE ADAPTOR IF REQUIRED).
4. SET THE CUEING LEVER (30) TO THE UP POSITION.
5. LIFT THE TONE ARM FROM THE REST AND SLOWLY MOVE IT TO THE RECORD SIDE. THE PLATTER WILL START TO ROTATE AND LOCATE THE TONE ARM OVER THE DESIRED POSITION OF THE RECORD.
6. PULL DOWN THE CUEING LEVER (30). THE TONE ARM WILL COME SLOWLY ON THE RECORDER AND START PLAYBACK.
7. AT THE END OF RECORD, THE TONE ARM WILL RETURN TO THE REST POSITION AUTOMATICALLY.
8. TO STOP MANUALLY, LIFT THE TONE ARM FROM THE RECORD AND RETURN IT TO THE REST.

REMARK : DUE TO THIS DEVICE DESIGNED PHONO AND AUX IN THE SAME CHANNEL. WHEN AUX JACK WAS PLUGGED BY 3.5MM PLUG, THE CHANNEL WILL SWITCH TO AUX FUNCTION AUTOMATICALLY. PLEASE REMOVE THE 3.5MM PLUG FROM THE AUX JACK(5) DURING PLAY THE PHONO.

● **PLAY SUSPENSION**

SET THE CUEING LEVER (30) TO THE UP POSITION WILL LIFE UP THE TONE ARM AND THEN STOP PLAYBACK TEMPORARILY

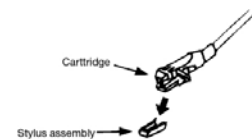

● PLAY EJECTION

PRESS THE EJECT BUTTON (16) ANYTIME DURING PLAYBACK WILL RETURN THE TONE ARM TO THE REST POSITION IMMEDIATELY.

Remark :

- DUE TO THE LENGTH OF THE RECORD IS VARIOUS, IF YOU FIND THE TONE ARM CANNOT RETURN AUTOMATICALLY AFTER PLAYBACK OF RECORD. PLEASE PRESS THE EJECT BUTTON AND RETURN THE TONE ARM BACK TO THE REST POSITION
- USERS SHOULD NOT CHANGE TO A MAGNETIC CARDRIDGE SYSTEM, OTHERWISE UNIT CAN'T BE CONNECTED ANYMORE TO AN AUX-IN OF MUSIC-CENTER

ADJUSTMENTS

ANTI-SKATING CONTROL

- SET THE ANTI-SKATING CONTROL (29) TO THE POSITION WHICH CORRESPONDING TO THE ADJUSTED STYLUS WORKING PRESSURE. IF THE WORKING PRESSURE IS 2 GRAMS, THE ANTI-SKATING CONTROL ALSO TO BE SET AT 2.

PLATTER SPEED ALIGNMENT

- DURING PLAYBACK OF RECORD, OBSERVE THE APPROPRIATE STRIP OF STROBE CALIBRATION DOTS FROM THE STROBE LENS. THE UPPER ONE IS FOR 33 RPM AND THE MIDDLE ONE IS FOR 45 RPM.
- IF THE STROBE DOTS APPEAR TO FLOWING TO THE RIGHT, IT MEANS THE PLATTER IS REVOLVING SLOWER THEN RATED SPEED. TURN THE PITCH CONTROL (33) TO THE " + " DIRECTION. IF THE STROBE DOTS APPEAR TO FLOWING TO THE LEFT, IT MEANS THE PLATTER IS REVOLVING FASTER THAN RATED SPEED. TURN THE PITCH CONTROL (33) TO THE " - " DIRECTION.
- ADJUST THE PITCH CONTROL (33) UNTIL THE STROBE DOTS DO APPEAR TO BE STATIONARY WITHOUT MOVING LEFT OR RIGHT.

TONE ARM STOPPING POSITION ALIGNMENT

- THE POSITION OF THE TONE ARM COMPLETE PLAYBACK AND RETURN TO THE REST STATION CAN BE ADJUSTED AT THE ALIGNMENT SCREW (27) AS FOLLOW:-
- BEFORE STARTING THE ALIGNMENT, PLEASE TAKE OUT THE HOLE COVERING RUBBER:-

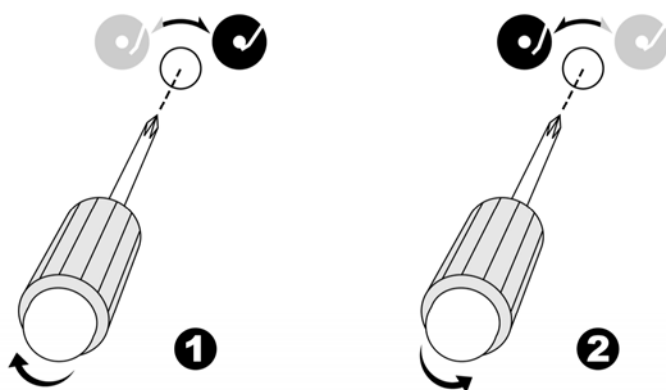

A) IF THE SYSTEM CANNOT COMPLETE THE PLAYBACK OF RECORD AND RETURN EARLIER

1) USE A CROSS HEAD SCREW DRIVER AND TURNING THE ALIGNMENT SCREW (34) INSIDE THE HOLE CLOCKWISE, THE STOPPING AND EJECT POSITION OF THE TONE ARM WILL MOVE MORE INWARD TO THE CENTER OF THE RECORD BEFORE PLAYBACK COMPLETION.

B) IF THE SYSTEM CANNOT RETURN TO REST POSITION AUTOMATICALLY AFTER PLAYBACK OF RECORD

2) USE A CROSS HEAD SCREW DRIVER AND TURNING THE ALIGNMENT SCREW (34) INSIDE THE HOLE ANTI-CLOCKWISE, THE STOPPING AND EJECT POSITION OF THE TONE ARM WILL MOVE MORE AWAY FROM THE CENTER OF THE RECORD BEFORE PLAYBACK COMPLETION.

REMARK:-

- THE STOPPING POSITION IS VERY SUBJECTIVE AMONG DIFFERENCE CUSTOMERS, PLEASE SELECT THE MOST SUITABLE POSITION BASED ON YOUR OWN RECORD COLLECTION. THE EX-FACTORY SETTING IS BASED ON THE MOST COMMON TEMPLATE.
- PLEASE CHECK THE STOPPING POSITION TIME BY TIME DURING ADJUSTMENT AND AVOID OVER TURNING OF THE SCREW INSIDE.

LINE OUT CONNECTION

YOU CAN CONNECT THE SYSTEM TO YOUR WHOLE HI-FI SYSTEM BY CONNECTING THE LINE OUT SOCKET (35) TO THE AUXILIARY INPUT SOCKET WITH A RCA CABLE (NOT PROVIDED).

MORE FEATURES

A. SLEEP SETTING (BY REMOTE CONTROL)

1. PRESS "SLEEP" BUTTON AND SLEEP INDICATOR "ZZZ" WILL SHOWN ON THE LCD DISPLAY (2).
2. KEEP PRESSING THE BUTTON TO ADJUST THE SLEEP TIMER IN THE ORDER OF 90 > 75 >60....15 MINUTES.
3. SYSTEM WILL STOP AND GOTO STANDBY MODE AUTOMATICALLY AFTER THE SELECTED TIMING.
4. TO CANCEL THE SLEEP MODE, PRESS " SLEEP " BUTTON UNIT IT REACHS "OFF" MODE.





REMARK:-

IF PRESS THE SLEEP BUTTON ONCE AND THE SLEEP INDICATOR " ZZZ " APPEAR ON THE LCD DISPLAY (2), THE SYSTEM WILL GOTO STANDBY MODE AUTOMATICALLY AFTER THE SELECTED MINUTES.

B. ALARM CLOCK SETTING (BY REMOTE CONTROL)

THIS FUNCTION ALLOWS THE SYSTEM TO TURN ON AUTOMATICALLY AND WAKE YOU UP BY CD, TUNER, USB OR SD MODE RESPECTIVELY.



FIRST, SET THE UNIT AT STANDBY MODE AND THEN PRESS & HOLD THE " TIMER " BUTTON TO ENTER THE SETTING MODE, THE LCD DISPLAY WILL SHOW SET TIME – SELECT SOURCE :-

- 1) WAKE UP SOURCE : PRESS THE " FUNCTION " BUTTON TO SELECT THE SOURCE FORM " TUNER FM " – " TUNER MW " - " USB  " - " SD  " – CD REPEATLY. PRESS " TIMER " BUTTON AGAIN AFTER SELECTED THE SOURCE.
- 2) WAKE UP TIME : PRESS SKIP UP  / DOWN  " BUTTON TO SET THE HOUR & MINUTES AND PRESS " TIMER " BUTTON " TO STORE THE MEMORY.

REMARK

- THE UNIT WILL SWITCH OFF AUTOMATICALLY AFTER SETTING THE ALARM. THE WAKE UP VOLUME IS PRESET AT LEVEL 20.
- IF THERE IS NO MUSIC SOURCE BEING DETECTED (SUCH AS USB/SD/CD) WHEN THE PRESET TIME IS REACHED, SYSTEM WILL DEFAULT TO TUNER MODE AUTOMATICALLY.
- FOR TUNER WAKE UP, THE SYSTEM WILL PRESET AT THE LATEST RADIO FRQUENCY BEING LISTENED BEFORE SWITCHING OFF.
- PLEASE SWITCH OFF THE SYSTEM MANUALLY DURING ALARM WAKE UP MODE AS THE SYSTEM WILL NOT TURN OFF AUTOMATICALLY AFTER ALARM ON MODE.

● ACTIVE/DE-ACTIVE TIMER FUNCTION

1. TO ACTIVE THE ALARM, PRESS ONCE THE " TIMER " BUTTON ON REMOTE HANDSET UNTIL THE TIMER INDICATOR "  " IS SHOWN ON LCD DISPLAY (2).
2. TO CANCEL ALARM FUNCTION BY PRESS ONCE AGAIN " TIMER " BUTTON UNTIL THE TIMER INDICATOR "  " DISAPPEAR.

C. PRE-SET EQ FUNCTION (BY REMOTE CONTROL)

THIS UNIT PROVIDES 4 DIFFERENCES SOUND MODE TO ENHANCE YOUR LISTENING EXPERIENCE. YOU CAN SELECT THE DESIRED EFFECT BY PRESSING THE " PRESET EQ" BUTTON REPEATEDLY AT FOLLOWING SEQUENCE:-



D. DISPLAY FUNCTION (BY REMOTE HANDSET)

PRESS TO INDICATE THE CURRENT TIME WHEN THE SYSTEMS IS OPERATING BY ANY MODE OF ALL FUNCTIONS.

REMOTE CONTROL TRANSMITTER

BUTTON DESCRIPTION

BATTERY INSTALLATION (BATTERY NOT PROVIDED)

THE INFRA-RED TRANSMITTER REQUIRE 2 PC AAA SIZE BATTERY FOR OPERATION

BUTTON DESCRIPTION		
ON/STANDBY	PRESS TO SWITCH ON/STANDBY THE SYSTEM	
FUNCTION	PRESS TO SELECT THE FUNCTIONS (TUNER-CD-USB-SD-PHON/AUX)	
DISPLAY	AT POWER ON : PRESS TO DISPLAY CURRENT TIME	
TUNIGN SKIP UP▶▶/DOWN◀◀	IN CD/MP3/WMA MODE : TO SELECT PREVIOUS / NEXT TRACK IN TUNER MODE : PRESS TO STEP UP/DOWN OF FREQUENCY	
BAND / PLAY/PAUSE▶	IN TUNER MODE : PRESS TO SELECT RADIO BAND IN CD/USB/SD MODE : PRESS ONCE TO START PLAYBACK. PRESS ONCE AGAIN TO STOP PLAYBACK TEMPORARILY	
FOLDER/PRE-DN▼	IN MP3/USB/SD MODE : PRESS TO SKIP DOWN THE ALBUM IN TUNER MODE : PRESS TO CALL DOWN THE PRESET MEMORY IN ORDER	
DOLFER/PRE-UP▲	IN MP3/USB/SD MODE : PRESS TO SKIP UP THE ALBUM IN TUNER MODE : PRESS TO CALL UP THE PRESET MEMORY IN ORDER	
STOP■	PRESS TO STOP CD/MP3 PLAYBACK OR CANCEL PROGRAMMED MEMORY	
SLEEP/TIMER	IN POWER ON MODE : PRESS TO ACTIVE SLEEP FUNCTION IN STANDBY MODE : PRESS AND HOLD TO ENTER ALARM SET UP MODE AND PRESS ONCE TO ACTIVE/DE-ACTIVE ALARM FUNCTION	
MEMORY/CLK-ADJ	IN CD MODE : PRESS TO ACTIVE CD ROGRAM FUNCTION IN TUNER MODE : PRESS TO ACTIVE PRESET STATION MODE IN STANDBY MODE : PRESS TO ADJUST CLOCK	
FM-ST/MOMO / PLAY MODE	IN TUNER MODE : PRESS TO SELECT FM STEREO OR FM MONO MODE IN CD/USB/SD MODE : PRESS TO ACTIVE REPEAT/RANDOM FUNCTION	
FIND / TS	IN MP3 MODE : PRESS TO ACTIVE MP3 SEARCH FUNCTION IN ENCODING MODE : PRESS TO ACTIVE TRACK SEPARATION FUNCTION	
REC	PRESS TO ACTIVE ENCODING/MP3 FILE COPY FUNCTION	
DEL/INFO	IN USB/SD MODE : PRESS TO DELETE THE FILE IN THE USB/SD MEMORY IN MP3 PLAYBACK MODE : PRESS TO ACTIVE ID3 FUNCTION	
VOLUME -/+	PRESS TO ADJUST VOLUME LEVEL UP/ DOWN	
PRESET EQ	PRESS TO SELECT DIFFERENCE EQ MODE FOR ENJOYMENT	

IMPORTANT NOTICE

Automatic standby mode

To comply with the ErP2 directive, the unit automatically switches to standby after approx. 15 minutes without a signal. (For instance in CD-Stop mode). To switch the unit on again, please follow the instructions mentioned in instruction manual.