

ENVIRONMENTAL PROTECTION



Do not dispose of this product with the normal household waste at the end of its life cycle. Return it to a collection point for the recycling of electrical and electronic devices. This is indicated by the symbol on the product, user manual or packaging.

The materials are reusable according to their markings. By reusing, recycling or other forms of utilization of old devices you make an important contribution to the protection of our environment.

Please contact your local authorities for details about collection points.



CAUTION - INVISIBLE LASER RADIATION WHEN OPENING THE COVER OR PRESSING THE SAFETY INTERLOCK. AVOID EXPOSURE TO THE LASER BEAM.

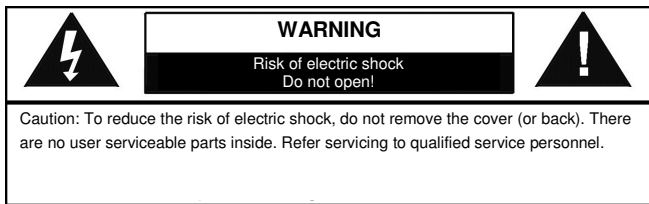

This symbol indicates the presence of dangerous voltage inside the enclosure, sufficient enough to cause electric shock.



This symbol indicates the presence of important operating and maintenance instructions for the device.

Safety, Environmental and Setup Instructions

- Use the device in dry indoor environments only.
- Protect the device from humidity.
- Do not open the device. **RISK OF ELECTRIC SHOCK!** Refer opening and servicing to qualified personnel.
- Connect this device to a properly installed and earthed wall outlet only. Make sure the mains voltage corresponds with the specifications on the rating plate.
- Make sure the mains cable stays dry during operation. Do not pinch or damage the mains cable in any way.
- Disconnect device warning: Main plug is used as the connection, so it should always remain ready operate.
- The mains plug is used as the disconnect device, the disconnect device shall remain readily operable.
- A damaged mains cable or plug must immediately be replaced by an authorized service center.
- In case of lightning, immediately disconnect the device from the mains supply.
- Children should be supervised by parents when using the device.
- Clean the device with a dry cloth only.
Do NOT use CLEANING AGENTS or ABRASIVE CLOTHS!
- Do not expose the device to direct sunlight or other heat sources.
- Install the device at a location with sufficient ventilation in order to prevent heat accumulation.
- Do not cover the ventilation openings!
- The ventilation should not be impeded by covering the ventilation openings with items, such as newspaper, table-cloths, curtains, etc.
- It shall be not be exposed to dripping or splashing and that no objects filled with liquids, such as vases, shall be placed on the apparatus.
- The unit should not be exposed to direct sunlight, very high or low temperature, moisture, vibrations or placed in dusty environment.
- Never attempt to insert wires, pins or other such objects into the vents or opening of the unit.
- Install the device at a safe and vibration-free location.
- No naked flame sources, such as lighted candles, should be placed on the apparatus.
- Install the device as far away as possible from computers and microwave units; otherwise radio reception may be disturbed.
- Do not open or repair the enclosure. It is not safe to do so and will void your warranty. Repairs only by authorized service/ customer center.
- The device is equipped with a "Class 1 Laser". Avoid exposure to the laser beam as this could cause eye injuries.
- Only use mercury and cadmium-free batteries.
- Batteries shall not be exposed to excessive heat such as sunshine, fire or the like.
- Used batteries are hazardous waste and NOT to be disposed of with the household waste!!! Return the batteries to your dealer or to collection points in your community.
- Keep batteries away from children. Children might swallow batteries. Contact a physician immediately if a battery was swallowed.
- Check your batteries regularly to avoid battery leakage.



Used batteries are hazardous waste and NOT to be disposed of with the household waste! As a consumer you are **legally obligated** to return **all batteries** for environmentally responsible recycling – no matter whether or not the batteries contain harmful substances*).

Return batteries free of charge to public collection points in your community or to shops selling batteries of the respective kind.

Only return fully discharged batteries.

*) marked Cd = cadmium, Hg = mercury, Pb = lead

General Description

- DAB/FM Digital Tuning System (20DAB+20FM Preset Stations by manual)
- AMS function (Automatic Memory System) (30DAB+30FM Preset Stations)
- RDS feature provide radio station name display & automatic time up-date
- CD|MP3|WMA and USB playback function provided
- Precise crystal is used for system operation
- Real time clock display with day-flag
- 12|24 Hour clock display
- Built in calendar with auto leap year handling within 2000-2099
- 4 mode dual alarms can be set to daily, weekday, week-end and single day independently
- Alarm output can be set to CD, DAB, FM or Buzzer sound
- Automatic or Manual search and Up, Down features are provided
- Electronic Volume Control (32 level)
- Back light with high-low dimmer
- Automatic change to standby mode after 15 minutes if not any sources playing.
- 5 Preset EQ (Flat, Rock, Classic ,Jazz ,Pop)
- Radio Frequency range:
 - FM: 87.5 ~ 108.0 MHz , 50 kHz | Step
 - DAB Band III 174.928-239.2 MHz
- CD playback function provided incl. below feature:
- CD Disc & MP3 Disc & WMA Disc
 - CD Disc
 - Programmable Memories: (Max. 32 tracks)
 - MP3 | WMA Disc
 - Pre-Memories: Max. 99 tracks)
- 8cm&12cm CD-R, CD-RW, Unclosed, Multi-Session, Mix Mode (CDDA only)
- High Speed Search for Pick-up
- Play, Pause, Fast Forward and Fast Backward Playback
- Repeat one / Repeat all /Repeat Folder/Random Playback
- USB Mode
 - Pro Memories: (Max. 99 tracks)

Assembly Drawing

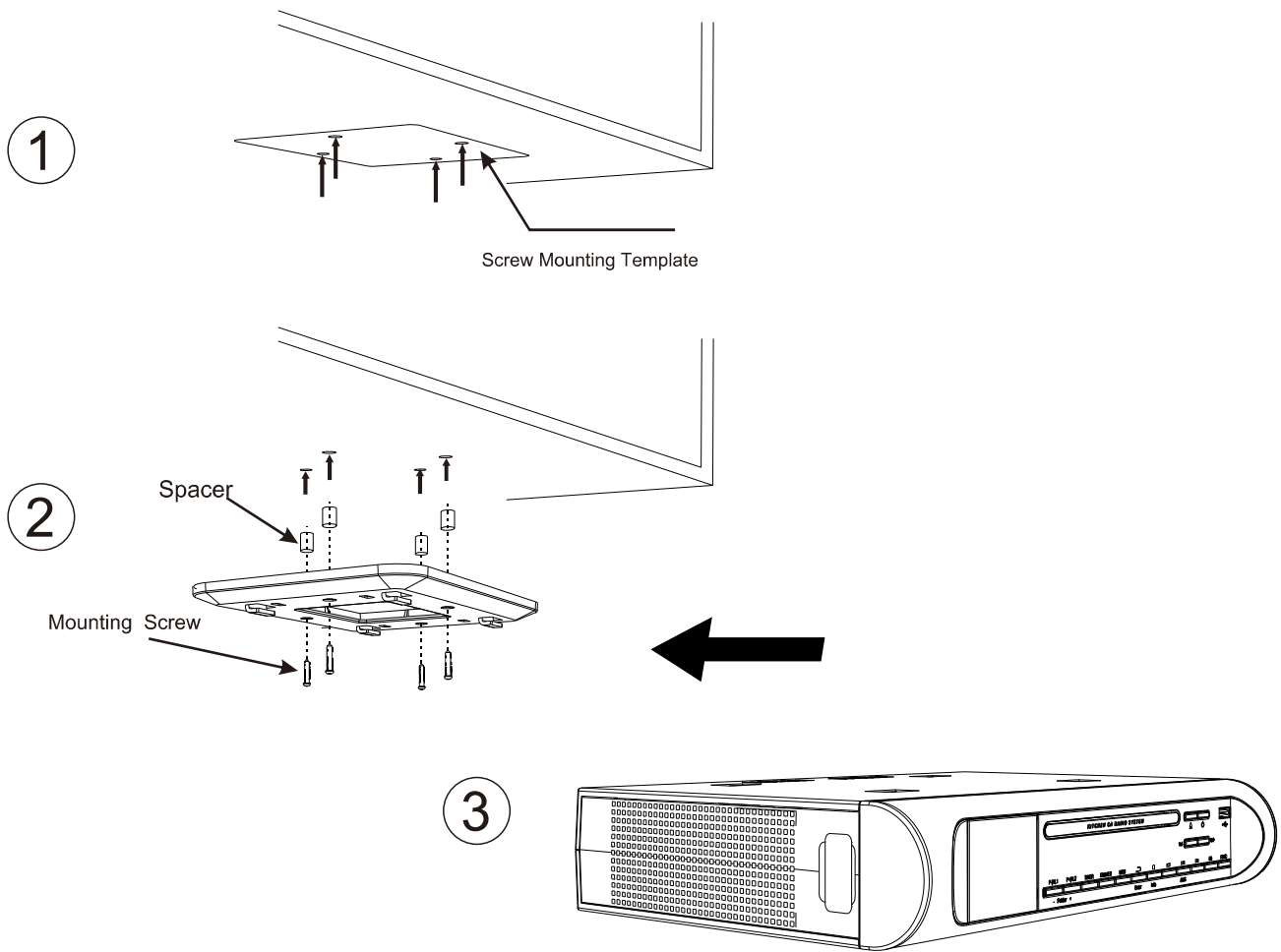

Install the unit as below 3 steps:

- 1) Place the mounting/drill template under the cabinet with tape, so the unit will be located where you want to and drill four holes with diameter 1/16 inch drill bit.
- 2) Fasten the screw as the above drawing with supplied Spacer+ mounting bracket+ long screw or mounting bracket + short screw
- 3) Buckle the unit to the mounting bracket

Warning: To prevent damage, do not place any heating or cooking appliance beneath the unit, install the unit as far as possible from a source of noise such as fridge, microwave oven etc.

Key List

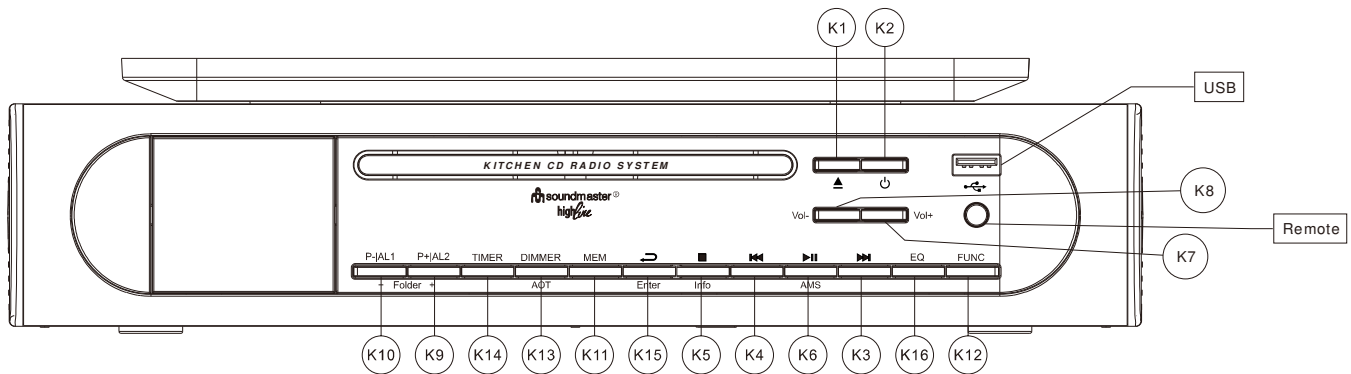

- | | |
|-------------------------------|---|
| K-1. Power: | Device power On Off |
| K-2. Open : | Control of CD tray to open or close |
| K-3. UP FF: | Tune up Radio station and forward of CD playback at that mode |
| K-4. DOWN RW: | Tune down Radio Station and backward of CD play back at that mode |
| K-5. Stop Info | Mode set and Stop of CD/USB playback ,
press to show information of station |
| K-6. AMS Pause Play: | AMS(Auto Memory Setting for radio station) , Play & Pause of CD/USB
play back at that mode |
| K-7. VOL+: | Volume increase |
| K-8. VOL-: | Volume decrease |
| K-9. Preset Folder+ / AL1: | Call back preset station for up / Review alarm at standby mode |
| K-10. Preset Folder- / AL2: | Call back preset station for down / Review alarm at standby mode |
| K-11. MEM: | Station Memory entry / Preset Station review |
| K-12. function: | DAB、 FM 、 CD、 USB selector |
| K-13. Dimmer / AOT: | Display backup light level control / Automatic OFF Timer |
| K-14. Timer: | Operate for timer function |
| K-15. Enter: | Function Setup Exit Setting, Enter or Confirm |
| K-16. EQ: | EQ(Flat Rock Classic Jazz Pop) |

Getting start

Power Up

- When device connect to power and it's powered up first time, Automatic update function will start automatically and scrolling text "Update, Please Wait" is display on LCD, it's may need few minutes depends signal strength and device working environment, when signal was received, the right time should be display on LCD accordingly. To terminate it, press any key during the period
- When the automatic system setting had been terminate by user or update un-succeed, the date and clock are defaulted to 01.01.2014, 0:00
- The all alarms are defaulted to 0:00
- The unit is switched to clock auto-run mode
- Default back light automatically set to dim from 23:00 to 05:59

Setup Device

When Auto-Run Mode, Press <INFO> once will entry to setting mode, the LCD display should be show as below:



Use <UP> or <DOWN> go to different mode sequentially as below

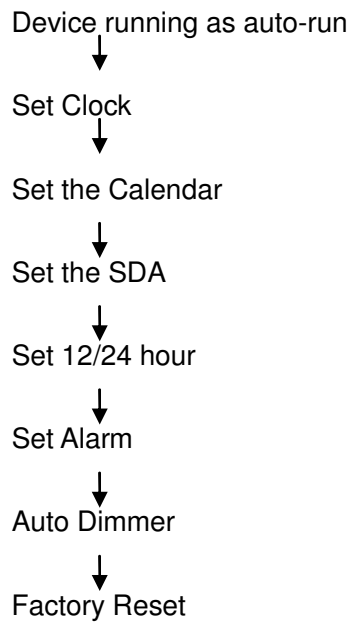

Set the clock

- Press <UP> or <DOWN> to select 'Set Clock' when set menu mode
- Press <enter> to enter Set Clock and display will show as below

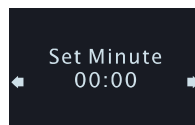

- Press <UP> or <DOWN> to set value of minutes.
- Press <enter> to Confirm minute Set and enter set hour mode, display show as below

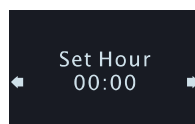

- Press <UP> or <DOWN> to set value of hours.
- Press <Enter> to Confirm hour value and return to set menu

Setup Calendar

- Press <UP> or <DOWN> to select 'Set Calendar' when set menu mode.
- Press <Enter> to setup value of calendar.

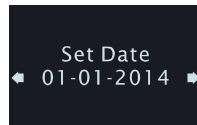

- Press <UP> or <DOWN> to set value of dates.
- Press <enter> to Confirm date value and enter to month selection, display show as below.

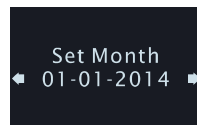

- Press <UP> or <DOWN> to select value of months.
- Press <enter> to Confirm it and enter to setting up year value, display show as below

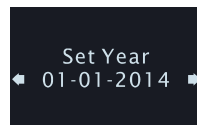

- Press <UP> or <DOWN> to select value of years, once it's meeting right value, press <Enter> confirm and return to setup Menu

Set the SDA

- Press <UP> or <DOWN> to set SDA when device stay on setting menu mode.
- Press <enter> to enter set SDA timer
- There are total 10 SDA timers for select .



- Press <UP> or <DOWN> to select number of SDA.
- Press <enter> to confirm selected timer and enter to set up it



- Press <UP> or <DOWN> to set value of date.
- Press <enter> to Confirm date and enter set month mode.



- Press <UP> or <DOWN> to set value of month.
- Press <enter> to Confirm month and enter set year mode.



- Press <UP> or <DOWN> to set value of year.
- Press <enter> to Confirm year and return to set menu.

Select Clock format which 12 or 24

- Press <UP> or <DOWN> to select 12/24 hour format when set menu mode, display show as below:

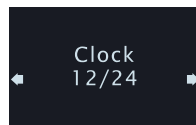

- Press <enter> to enter set 12/24 hour format
- Press <UP> or <DOWN> to select 12 or 24 hour format.
- Press <enter> to Confirm select and return to set menu.

Setup the alarm

- Press <UP> or <DOWN> to select 'Set Alarm' when stay on the setting menu display show as below :

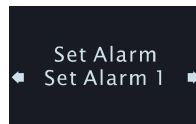

- Press <enter> to enter to be start setup alarm :
- Press <UP> or <DOWN> to select number of alarm.
- Press <enter> to confirm selected number and enter to Minute of alarm selection, display show as below

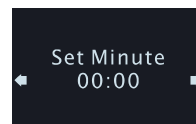

- Press <UP> or <DOWN> to setup value of minute for alarm.
- Press <enter> to confirm minute and enter to hour of alarm selection, display show as below

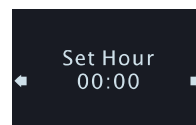

- Press <UP> or <DOWN> to set value of hour for alarm.
- Press <enter> to confirm selected hour value and enter to select output of alarm active:

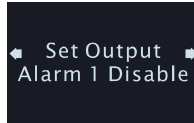

- there are five kinds of choices, it is respectively as table 1

Kinds	Means	Alarm duration time
Disable	Alarm is disable (default)	0
DAB	DAB sound for alarm active	60 minutes
FM	FM sound for alarm active	60 minutes
Buzzer	Buzzer sound for alarm active	10 minutes
CD	CD sound for alarm active	60 minutes

Table (1)

- Press <UP> or <DOWN> to select the kind of output, if choose CD output mode, you have to put the CD into the device, otherwise the alarm by Buzzer will take over
- Press <enter> to Confirm it and enter to days selection, display show as below

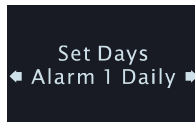

- There are ten kinds of choices, it is respectively as table 2

Kinds	Means
Daily	Alarm work in every day
Weekday	Alarm work in weekday
Weekend	Alarm work in weekend
Sun, Mon ... Sat	Alarm work in one day of week

Table 2

- Press <UP> or <DOWN> to select the kind alarm active arrangement
- Press <enter> to Confirm the select and return to set menu.

Set Auto Dimmer

- Press <UP> or <DOWN> to select ' Auto Dimmer ' when stay on setup menu stage.
- Press <enter> to enter set auto dimmer and the LCD display screen show as bellow

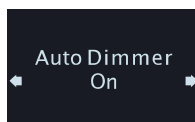

- Press <UP> or <DOWN> to select ON or OFF. Default is On
- Press <enter> to Confirm selection and return to set up menu.
- When you choose On, the default back light automatically set to dim from 23:00 to 05:59
- When you choose Off, the device won't dim the back light automatically.

Set factory reset (Be careful to use this action)

When stay on setup menu and press <UP> or <Down> to select "Factory Reset"



- Make sure you want delete all setup and reset the device to factory default, Press <enter> to done it.

Using Device

Once Automatic done or finish all setup, Device ready for use now.

Using Cooking Timer

- Press <Timer> once to entry the timer mode, Display show as below:



- Press <UP> or <DOWN> to choose the five value (00:10 or 00:15 or 00:30 or 00:40 or 1:00) , press <Timer> to start counting.
- press <preset +> or <preset -> to choose the ten value(00:10 /00:15 / 00:30 / 00:40 / 1:00/01:10/01:20/01:30/01:40/02:00) , press <Timer> to start counting.
- if you want to set any time you need, press<timer>once, then press <Info> to set minute by <UP> and <Down>,then press <Enter> to set hour by <UP> and <Down>,then press <enter> to confirm the set,, press <Timer> to start counting.
- When the timer is running press <Timer> could be pause it or press <Timer> again to continue.
- Press and hold <Timer> for 2 seconds to terminate the timer and leave, when the timer is running.
- Beep sound alarm is selected,
 - a. Sound of beep toggles at the Speaker
 - b. The duration of alarm is 10 minutes
- Press any key to terminate the currently active alarm.

Listen the radio DAB

- Press <**Power**> once to turn on the radio.
- Press <**FUNC**> to select device work mode to DAB



- Electronic Volume Control
 - a. Press <VOL+ > once, to increase speaker volume by one step. Hold for continually.
 - b. Press <VOL-> once, to decrease speaker volume by one step. Hold for continually.

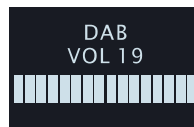

- How to listen DAB station
 - a. When device first to using DAB , Automatic Scan function will start automatically and "Scanning" on LCD as below :

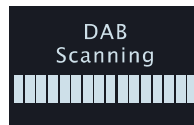

- b. Till the action finish ,Select DAB station
- c. Press <UP> or <DOWN>once to select DAB station list.
- d. Press < enter > once to confirm and tune to the station.
- e. Store station into preset
- f. Press <Preset> once to select location of preset mode.
- g. Press <Up> or <Down> to change location.
- h. Press and hold < enter > to store value of station into current location.
- i. Another way to search stations, In DAB mode, Press and hold <Info> until the display show "Station scan", then press <Enter> to choose "Manual tune" from 174.928-239.200 MHz

- Recall the preset
 - a. Press <**MEM**> once to select location of preset mode, display show on below information

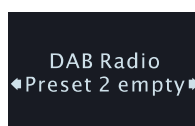

- b. Press <Up> or <Down> to change location.
- c. Press <Enter> to confirm select and recall the frequency.

- How to using Auto Scan
 - a. Press and hold **<AMS>** for 2 seconds to active about function mode.
 - b. At the moment, the device will automatically scan the DAB station and store the station that had been scanned until scan up all the frequency or stored all the memory station, it will exit automatically.

- Review the information of station
 - a. Press **<info>** to review information of station.
 - b. There are Seven kinds of choices, it is respectively:
 1. Station frequency and block number
 2. Data rate
 3. Station RSSI
 4. Signal error Rate
 5. DLS (Scrolling text)
 6. Program type
 7. Station name

How to Listen FM Radio

Press <Power>key to turn device on, press <Func> select work mode to FM, Display should be show as below:

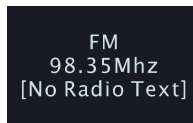

- How to search station
 1. When the radio is ON, press **<UP>** once to change the receiving frequency up by 1 step
 2. Press **<DOWN>** once to change the receiving frequency down by 1 step.
 3. Press and hold **<UP>** to search the next radio station automatically by moving the receiving frequency up.
 4. Press and hold **<DOWN>** to search the next radio station automatically by moving the receiving frequency down.

- How to store station into preset location
 1. Press **<MEM>** once to select location of preset mode.
 2. Press **<Up>** or **<Down>** to change location.
 3. Press and hold **< enter >** to store value of station into The current location.

- Recall the presented station
 1. Press **<MEM>** once to select location of preset.
 2. Press **<Up>** or **<Down>** to change location.
 3. Press **<enter>** to Confirm select and recall the frequency.

- How to set up station by AMS (Automatic Memory Setup)
 1. Press and hold <AMS> for 2 seconds to active AMS mode.
 2. In this mode, the radio will automatically scan the radio station and store the station that had been scanned until scan up all the frequency or stored all the memory station, it will exit automatically.

- How to Review stored station:
 1. Press and hold <MEM> to enter select list of AMS store mode.
 2. Press <Up> or <Down> to select station.
 3. Press <Enter> to confirm select and tune to new frequency

- How to enable or disable stereo feature

If received a weak station that may cause background noise, user can be stereo feature to improve sound quality.

 1. Press <INFO> for 2 seconds to 'FM set menu' mode.
 2. Press <UP> or <DOWN> to select 'Audio setting'.
 3. Press <Enter> Confirm select and enter 'Audio setting' set mode.
 4. Press <Up> or <DOWN> to select set.
 5. Press <enter> Confirm and return to 'FM set menu' mode.

Review information of station

1. Press <info> to review information of station.
2. There are three kinds of choices, it is respectively:
 - ✓ Station text
 - ✓ Station Program type
 - ✓ Station RSSI

Listen Music from CD

Press <Power>key to tune device on , press <Func> select work mode to CD or press <“Open|Close”>key to open CD tray, Display should be show as below:

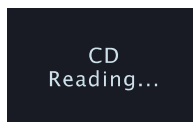

How to play a CD|MP3 CD

1. Press <Open> to open tray of CD and put CD media to tray, press <Open|Close> key again to close door of CD tray, at the moment , device will catch data from CD and “Reading, ... “ for about 5-10 seconds, it's will depends CD quality .
2. Once the CD read and confirm it's workable format, device will play from beginning of play list if not any key press.
3. When need to pause for the moment under playing, press “Play|Pause” once, press once will play again.

4. Press "Repeat/Enter" to select play back mode as "rep one", "rep all" or "random"
5. Press and hold "UP | FF" to fast speed forward, press once to next track
6. Press and hold "Down | RW" to Fast speed rewind, press once back to previously track.
7. Press folder <UP> or <DOWN> to select folder for first of program list.
8. Let device play under Pre-Program selected music (Pre-Program play)
 - a. Press <MEM> once to program mode when stop mode.
 - b. Press <UP> or <DOWN> to select tack for first of program list.
 - c. Press <MEM> again to select tack for next. Up to 64
 - d. Press <play> to confirm the setting and play.
 - e. Press <stop> twice to cancel program play

Listen music from a USB

Press <Power>key to turn device on , press <Func> select work mode to USB work mode, Display should be show as below:

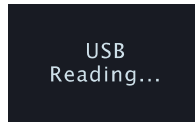

- a. Insert USB-Disk into UBS jack, device will reading.
 1. The device seek complete, device will play from beginning of play list if not any key press.
 2. Press "Play|pause" to play or Pause under music play back
 3. Press "Enter" to select play back mode as Rep one ,rep all, rep fol,random
 4. Press and hold "UP | FF" to fast speed forward, press once to next track
 5. Press and hold "Down | RW" to Fast speed rewind, press once back to previously track.
- b. Program play
 1. Press <MEM> once to program mode when stop mode.
 2. Press <UP> or <DOWN> to select tack for first of program list.
 3. Press folder <UP> or <DOWN> to select folder for first of program list.
 4. Press <MEM> again to select tack for next. Up to 64
 5. Press <Play> to confirm the setting and play.
 6. Press <Stop> twice to cancel program play

Electronic Volume Control

1. Press <VOL+ > once, to increase speaker volume by one step. Hold for continually.
2. Press <VOL-> once, to decrease speaker volume by one step. Hold for continually.
3. Adjust Volume control sound output to a comfortable level , don't make it too loud

Using AOT (Automatic OFF Timer)

The function let user setup a onetime timer to let device automatic power off

1. Press <AOT> once to active AOT function, if device stay on the standby, will turn on the device. the display will show as below:



2. Press the key every time will change each 5 minutes, value of timer since 90 to OFF.
3. Press other key to start its corresponding function with the AOT timer is run at background
4. When no key has been pressed for 15 seconds, the system exit AOT timer display mode, but the AOT timer is run at background
5. Once <AOT> was press, the current AOT value should show on display.
6. If want to cancel the AOT, press <AOT> several times until it to OFF.

LED Back Light Dimmer

1. At the any mode, press <Dimmer> 2 seconds to select dimmer high or dimmer low, the display will show as below:

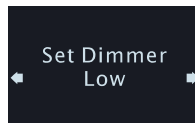

2. Select dimmer high with high level back light, select dimmer low with low level back light

Remote control:

Key Mark	Function
	Device power On Off
EQ	EQ(Flat Rock Classic Jazz Pop)
VOL-	Volume decrease
VOL+	Volume increase
Repeat	Select play mode of rep one/rep all/random for CD/USB
	Tune down Radio Station and backward of CD/USB play back at that mode
	,AMS(Auto Memory Setting for radio station) , Play & Pause of CD/USB play back at that mode
	Tune up Radio station and forward of CD/USB playback at that mode
Func	DAB、 FM 、 CD、 USB selector
/Fol-	Call back preset station for down
/Info	Mode set and Stop of CD/USB playback , press to show information of station
/Fol+	Call back preset station for up
	Control of CD tray to open or close
DIM/AOT	Display backup light level control/Automatic OFF Timer
MEM	Station Memory entry/ Preset Station review
Enter	Function Setup Exit Setting, Enter or Confirm
AL1	Review Alarm1
AL2	Review Alarm2
Timer	Operate for timer function
	Turn off the sound



Technical Data

Input voltage: DC 5.5V,2A
 Power consumption: 12W
 Radio Frequency range: FM: 87.5 ~ 108.0 MHz , 50kHz | Step
 DAB Band III 174.928-239.2 MHz
 Store temperature: -10°to +65°
 Operating temperature: 0°to +45°

Specifications are subject to change without further notice.

Copyright by Wörlein GmbH

